

02

accessories free standing
accessories accesorios
complementos

2016

COSMIC



COSMIC

Activarse, relajarse, sentirse cómodo... en el baño nos reencontramos con **nosotros mismos**, a través de una serie de objetos que **trascienden** lo meramente funcional.

Stimulation, relaxation, comfort... *the bathroom reintroduces us to ourselves through objects that transcend the merely functional.*



bath . experiences

cosmic	006
designawards	008
thecreators	010
showroom	012
thecollections	014

ACCESORIOS / ACCESSORIES / ACCESSOIRES / ACCESSORI /
ACESSÓRIOS / ACCESSOIRES / ACCESSOIRES

	014
ARCHITECT	016 NEW
BATH LIFE	030
BLACK & WHITE	040
CONTRACT	050
EXTREME	060
INOX	068
LOGIC	076
MINIMALISM	086
ORGANICS	096
PROJECT	104
WORKING	114

COMPLEMENTOS / FREE STANDING ACCESSORIES / ACCESSOIRES A POSER /
ARTICOLI D'APPOGGIO E OGGETTISTICA / COMPLEMENTOS /
ACCESSOIRES STANDMODELLE / LOSSTAANDE ACCESSOIRES

	124
BASKET	126
ORGANICS	132
SAKU	138 NEW

displays	145
-----------------	-----

salesconditions	150
------------------------	-----

CONDICIONES GENERALES DE VENTA / GENERAL SALES CONDITIONS / CONDITIONS
GÉNÉRALES DE VENTE / CONDIZIONI GENERALI DI VENDITA / CONDIÇÕES GERAIS DE VENDA /
ALLGEMEINE VERKAUFSBEDINGUNGEN / ALGEMENE VERKOOPVOORWAARDEN

technicalspecifications	152
--------------------------------	-----

MATERIALES / MATERIALS / MATÉRIAUX / MATERIALI / MATERIAIS / MATERIAL / MATERIALEN



cosmic

Cosmic entiende el cuarto de baño como un reflejo más de la **personalidad** de cada individuo y su búsqueda del **bienestar** a través del **diseño**.

Una de las ofertas más globales y sugestivas existentes en el mercado: accesorios, muebles, lavabos, bañeras, platos de ducha, grifería, iluminación, espejos y complementos.

*Cosmic conceives the bathroom as an added reflection of a person's **personality** and the search for **wellbeing** through **design**. One of the most global and suggestive offers on the market: accessories, furniture, washbasins, bathtubs, shower trays, fittings, lightings, mirrors and complements.*





design awards

2009

Design Plus colección Flow | *Design Plus Flow collection*

2007

Delta plata colección Simplex | *Silver Delta Simplex collection*

Design plus colección Block | *Design Plus Block collection*

2003

Príncipe Felipe a la excelencia empresarial | *Principe Felipe for business excellence*

Calidad del diseño en la empresa (BCD-CCB) | *Design quality in the company*

2002

Lux Plata campaña de comunicación | *Silver Lux communication campaigns*

2001

Lux Oro campaña de comunicación | *Gold Lux communication campaigns*





Miquel de Mas



Xavier Claramunt



Willi Kunzel



Núria Coll



Martín Ruiz Azua



Gerard Moliné



Jonathan Daifuku



Carles Ferruz



Emili Padrós



Ana Mir



Ricard Ferrer



Àlex Armenter

the creators

A lo largo de la historia **Cosmic Studio** ha diseñado y desarrollado multitud de colecciones que se han convertido en **clásicos**, y ha colaborado y coordinado el trabajo de **reconocidos diseñadores**.

*Over the years the **Cosmic Studio** has been designing and developing numerous collections that have become **classics**. It has also collaborated with and coordinated work by **renowned designers**.*





showroom

Cosmic showroom es un espacio situado en la sede central de Industrias Cosmic, S.A.U. donde disfrutar de la **experiencia** del **contacto** con el **producto**. Lavabos, bañeras, duchas, mobiliario, griferías y accesorios...

*Cosmic Showroom, situated at the central office of Industrias Cosmic, S.A.U., is a place to **experience** the **contact** with the **product**. Washbasins, bathtubs, shower trays, cabinets, faucets and accessories...*

CERDANYA, 2
POL. IND. LA BORDA
P.O. BOX 184
08140 CALDES DE MONTBUI
T. +34 938 654 277
info@icosmic.com







accessories

architect	016	NEW
bath life	030	
black & white	040	
contract	050	
extreme	060	
inox	068	
logic	076	
minimalism	086	
organics	096	
project	104	
working	114	



De las formas **arquitectónicas** surgen multitud de piezas que destacan por su **resistencia**. Colección completa de accesorios con un diseño **atemporal** y **elegante**.

*A multitude of pieces come out of **architectonic** forms that dominate with their **resistance**. A comprehensive collection of accessories with a **timeless** and **elegant** design.*

archi tect

DESIGN BY COSMIC STUDIO

Acabados
Finishes
Finitions
Finiture
Acabamentos
Oberflächen
Afwerkingen



Cromo
Chrome
Chromé
Cromo
Cromo
Chrom
Verchromd

FIJACIÓN TRADICIONAL TRADITIONAL FIXING

225 01 21

COLECCIÓN / COLLECTION / COLLECTION / COLLEZIONE / COLEÇÃO / KOLLEKTION / COLLECTIE

ACABADOS / FINISHES / FINITIONS / FINITURE / ACABAMENTOS / OBERFLÄCHEN / AFWERKINGEN

MODELO / TYPE / MODÈLE / MODEL / MODELO / MODELL / MODEL

SISTEMA DUAL DUAL SYSTEM

225 01 21 D

COLECCIÓN / COLLECTION / COLLECTION / COLLEZIONE / COLEÇÃO / KOLLEKTION / COLLECTIE

ACABADOS / FINISHES / FINITIONS / FINITURE / ACABAMENTOS / OBERFLÄCHEN / AFWERKINGEN

MODELO / TYPE / MODÈLE / MODEL / MODELO / MODELL / MODEL

SISTEMA DUAL / DUAL SYSTEM / SYSTÈME DUAL / SISTEMA DOPPIO / SISTEMA DUAL / DUALES SYSTEM / DUAL SYSTEME

NEW



Carga estática
de más de 25 KG

*Static load
of over 25 kg*



Resistente
a impactos

*Impact
resistance*



Montaje sin ruido
fácil y rápido

*Quick, easy,
silent installation*



Removable

Removable

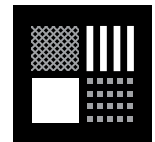

Efectivo en diferentes
superficies*

*Works with
different surfaces**

Características

Fácil instalación: tornillo de doble paso.
Fijaciones ocultas. Anticorrosión.

Features

*Easy installation: double pitch screw.
Hidden attachments. Anti-corrosion.*

Caractéristiques :

Facile installation: vis à double pas.
Fixations occultes. Anti-corrosion.

Caratteristiche:

*Facile installazione: vite a doppio passo.
Fissaggio nascosto. Anticorrosivo.*

Características:

Fácil instalação: parafuso de dupla
passagem. Fixações ocultas.
Anti-corrosão.

Eigenschaften:

*Einfache montage: doppel-pass-schraube.
Unsichtbare Befestigungen. Korrosionsschutz.*

Kenmerken:

Eenvoudig te monteren: schroef met
dubbele draad. Verborgene bevestigingen.
Corrosiewerend.

Sistema Dual

La colección Architect presenta como novedad el sistema de instalación dual, que permite sujetar los accesorios de baño con y sin taladros. Con el adhesivo Smart-fix, elaborado en exclusiva para la firma, se facilita el montaje sin la necesidad de hacer agujeros en la pared.

Dual System

Our updated Architect collection now includes a dual installation system for installing bathroom accessories with or without a drill. Smart-fix adhesive, designed exclusively for our firm, means that bathroom accessories can be installed without drilling holes in the wall.

Système Dual

La collection Architect présente comme nouveauté le système d'installation double, qui permet de fixer les accessoires de bain avec ou sans perceuse. Grâce à l'adhésif Smart-fix, conçu exclusivement pour notre marque, le montage est plus simple car vous n'aurez plus besoin de faire des trous.

Sistema Doppio

La collezione Architect presenta la novità del doppio sistema di fissaggio, che consente il montaggio degli accessori del bagno con e senza il ricorso al trapano. Grazie all'adesivo Smart-fix, studiato appositamente per il marchio, il montaggio è facilitato e non c'è bisogno di praticare fori nella parete.

Sistema Dual

A coleção Architect apresenta o sistema de instalação dual, que permite fixar os acessórios de banho com e sem furos. Com o adesivo Smart-fix, desenvolvido exclusivamente para a empresa, a montagem é facilitada sem a necessidade de fazer furos na parede.

Duales System

Die Kollektion Architect präsentiert als Neuheit das duale Installationssystem, mit dem Badezimmeraccessoires mit oder ohne Bohrlöcher befestigt werden können. Mit dem Klebstoff Smart-fix, der exklusiv für die Firma entwickelt wurde, erfolgt die Montage einfach und ohne störende Bohrlöcher in der Wand.

Dual System

De Architect-collectie presenteert het nieuwe dual-installatiesysteem waarmee badkameraccessoires met of zonder boren kunnen worden bevestigd. Met Smart-fix kleefmiddel, dat exclusief voor de firma ontwikkeld is, wordt de montage eenvoudiger, zonder dat er gaten in de muur hoeven te worden gemaakt.

* Cerámica, porcelana, materiales vitrificados o mármoles compactos, e incluso superficies con una rugosidad de hasta 0,5 milímetros de espesor.

* Ceramic, porcelain, glazed surfaces, compact marble, even surfaces with roughness up to 0.5 mm thickness.



architect

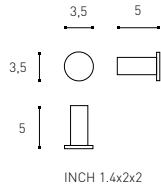

INCH 1.4x2x2

- COLGADOR
HANGER
PATÈRE
APPENDINO
CABIDE
HAKEN
KLEERHAAK

MX 205 01 21
\$ 480.00

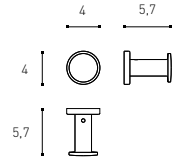

INCH 1.6x2.2x2.2

- COLGADOR
HANGER
PATÈRE
APPENDINO
CABIDE
HAKEN
KLEERHAAK

NEW 205 01 21 D
\$ 1,180.00

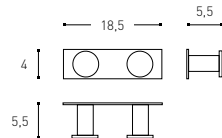

INCH 7.3x2.2x1.6

- COLGADOR DOBLE
DOUBLE HANGER
PATÈRE DOUBLE
APPENDINO DOPPIO
CABIDE DUPLIO
DOPPELTER HAKEN
DUBBELE KLEERHAAK

MX 205 01 22
\$ 1,280.00

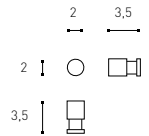

INCH 0.8x1.4x1.4

- PORTAGUANTES
HANGER
PATÈRE
APPENDINO
PORTA-LUVAS
HAKEN
KLEERHAAK

MX 205 01 20
\$ 280.00

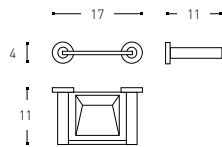

INCH 6.7x4.3x1.6

- JABONERA
SOAP DISH
PORTE-SAVON
PORTASAPONE
SABONETEIRA
SEIFENSCHALE
ZEEPBAKJE

205 01 32
\$ 1,440.00

NEW 205 01 32 D
\$ 1,620.00

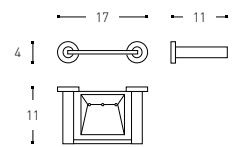

INCH 6.7x4.3x1.6

- JABONERA BAÑERA
SOAP DISH BATHTUB
PORTE - SAVON BAIGNOIRE
PORTASAPONE VASCA
SABONETEIRA BANHEIRA
SEIFENSCHALE FÜR BADEWANNE
BADZEEPBAKJE

MX 205 01 33
\$ 1,440.00

NEW 205 01 33 D
\$ 1,550.00

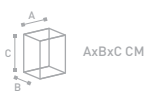

AxBxC CM

020

MX PRODUCTO DE STOCK EN MÉXICO

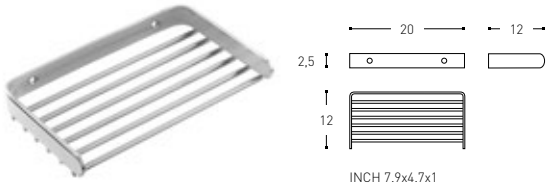

- JABONERA REJILLA
GRILLE SOAP DISH
PORTE SAVON GRILLE
PORTASAPONE GRIGLIA
SABONETEIRA GRELHA
GITTERSEIFENSCHALE
ZEEPBAKJE ROOSTER

MX 290 02 39
\$ 920.00

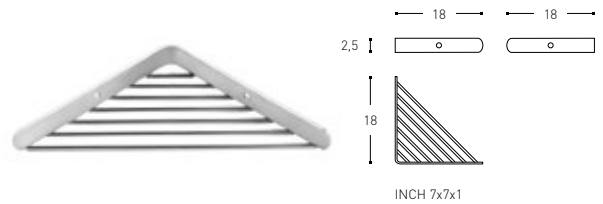

- JABONERA REJILLA RINCÓN
GRILLE CORNER SOAP DISH
PORTE - SAVON GRILLE D'ANGLE
PORTASAPONE GRIGLIA ANGOLO
SABONETEIRA GRELHA DE CANTO
GITTERECKSEIFENSCHALE
ZEEPBAKJE ROOSTER - EN HOEKVORM

290 02 30
\$ 920.00



- ○ ◆ PORTAVASO
GLASS HOLDER
PORTE - VERRE
PORTABICCHIERE
PORTA - COPO
GLASHALTER
BEKERHOUDER

205 01 52
\$ 1,440.00

NEW 205 01 52 D
\$ 1,590.00



- PORTACEPILLOS ENCIMERA
FREE STANDING BRUSH-HOLDER
PORTE-BROSSE À DENTS À POSER
PORTASPAZZOLINI DA APPOGGIO
PORTA-ESCOVA DE DENTES DE BAN-
CADA
ZAHNBÜRSTENHALTER FÜR AUFLAGE
TANDENBORSTELHOUDER VOOR BLAD

205 01 51
\$ 1,180.00

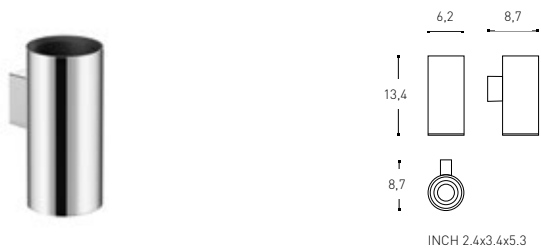

- PORTACEPILLOS
BRUSH-HOLDER
PORTE-BROSSE À DENTS
PORTASPAZZOLINI
PORTA-ESCOVA DE DENTES
ZAHNBÜRSTENHALTER
TANDENBORSTELHOUDER

MX 205 01 53
\$ 1,460.00

NEW 205 01 53 D
\$ 1,580.00



- DOSIFICADOR ENCIMERA
FREE STANDING SOAP DISPENSER
PORTE-SAVON LIQUIDE À POSER
DISPENSER DA APPOGGIO
DISPENSADOR SABONETE DE BANCADA
AUFLAGESEIFENSPENDER
DOSEERDER VOOR BLAD

205 01 04
\$ 1,620.00

architect

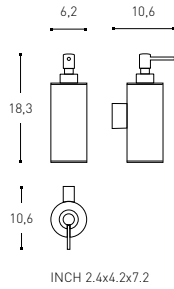

INCH 2.4x4.2x7.2

- Ⓞ DOSIFICADOR SOAP DISPENSER PORTE-SAVON LIQUIDE DISPENSER DISPENSADOR SABONETE SEIFENSPENDER DOSEERDER

MX 205 01 03 \$ 1,460.00

NEW 205 01 03 D \$ 1,690.00

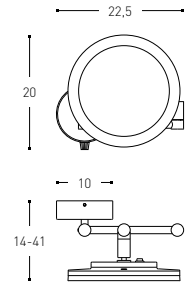

INCH 8.8(3.9)x5.5-16.1x7.9

- Ⓞ △ ◆ ESPEJO AUMENTO (X3) LED MAGNIFYING MIRROR (X3) LED MIRROR GROSSISSANT (x3) LED SPECCHIO AUMENTO (X3) LED ESPELHO AUMENTO (X3) LED VERGRÖSSERUNGSSPIEGEL (x3) LED VERGROOTSPIEGEL (X3) LED

205 01 83
\$ 9,700.00

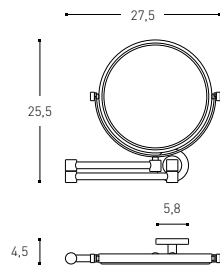

INCH 10.8(2.3)x1.8x10

- Ⓞ △ ◆ ESPEJO AUMENTO (X3) MAGNIFYING MIRROR (X3) MIRROR GROSSISSANT (x3) SPECCHIO AUMENTO (X3) ESPELHO AUMENTO (X3) VERGRÖSSERUNGSSPIEGEL (x3) VERGROOTSPIEGEL (X3)

205 01 84
\$ 3,170.00

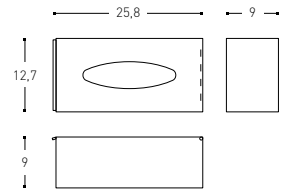

INCH 10.1x3.5x5

- Ⓞ CAJA KLEENEX TISSUE BOX BOÎTE KLEENEX COFANETTO KLEENEX CAIXA PARA LENÇOS DE PAPEL KLEENEX-BOX TISSUE DOOS

NEW 290 02 20 \$ 1,300.00

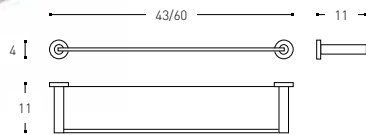

INCH 16.9/23.6x4.3x1.6

- Ⓞ ◆ ESTANTE VIDRIO GLASS FLAT SHELF TABLETTE VERRE MENSOLA VETRO PRATELEIRA VIDRO GLASABLAGE GLAZEN REK

205 01 44 43 CM / INCH 16.9 \$ 1,620.00

NEW 205 01 44 D 43 CM / INCH 16.9 \$ 1,810.00

205 01 45 60 CM / INCH 23.6 \$ 2,010.00

NEW 205 01 45 D 60 CM / INCH 23.6 \$ 2,170.00

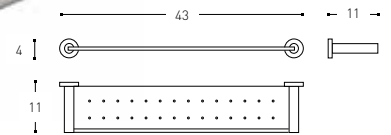

INCH 16.9x4.3x1.6

- Ⓞ ○ ESTANTE INOX STAINLESS STEEL FLAT SHELF TABLETTE INOX MENSOLA INOX PRATELEIRA INOX EDELSTAHLABLAGE ROESTVRIJ STAAL REK

MX 205 01 46 \$ 1,900.00

NEW 205 01 46 D \$ 2,060.00



AxBxC CM

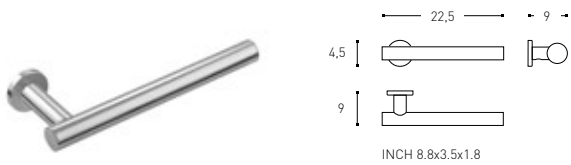

● TOALLERO
TOWEL RACK
PORTE - SERVIETTE
PORTASALVIETTE
TOALHEIRO
HANDTUCHSTANGE
HANDDOEKHOUDER

205 01 67
\$ 1,100.00

NEW 205 01 67 D
\$ 1,210.00

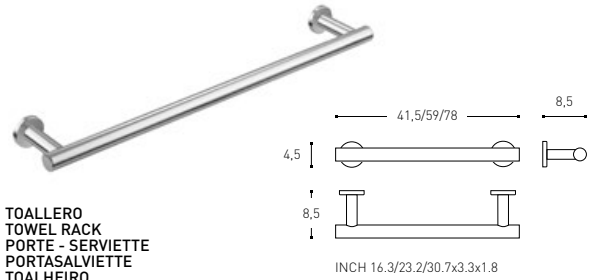

● TOALLERO
TOWEL RACK
PORTE - SERVIETTE
PORTASALVIETTE
TOALHEIRO
HANDTUCHSTANGE
HANDDOEKHOUDER

MX 205 01 64 41,5 CM / INCH 16.3
\$ 1,420.00

NEW 205 01 64 D 41,5 CM / INCH 16.3
\$ 1,600.00

MX 205 01 65 59 CM / INCH 23.2
\$ 1,560.00

NEW 205 01 65 D 59 CM / INCH 23.2
\$ 1,710.00

205 01 66 78 CM / INCH 30.7
\$ 1,670.00

NEW 205 01 66 D 78 CM / INCH 30.7
\$ 1,850.00

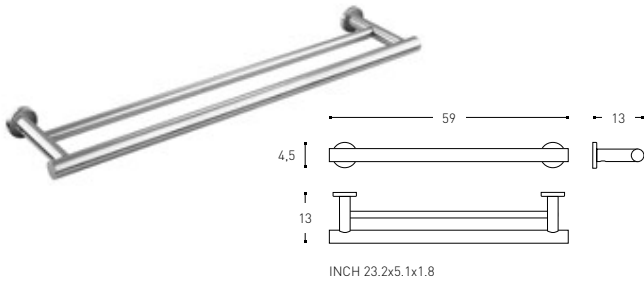

● TOALLERO DOBLE
DOUBLE TOWEL RACK
PORTE - SERVIETTE DOUBLE
PORTASALVIETTE DOPPIO
TOALHEIRO DUPLO
DOPPELTE HANDTUCHSTANGE
DUBBELE HANDDOEKHOUDER

205 01 61
\$ 2,030.00

NEW 205 01 61 D
\$ 2,220.00

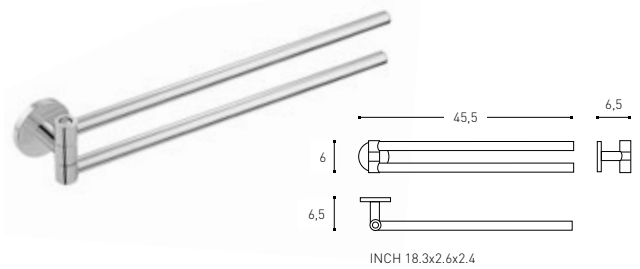

● TOALLERO GIRATORIO DOBLE
DOUBLE SWIVEL TOWEL RACK
PORTE - SERVIETTE PIVOTANT DOUBLE
PORTASALVIETTE A SNODO DOPPIO
TOALHEIRO GIRATORIO DUPLO
DOPPELTE HANDTUCHSTANGE SCHWENKBAR
DUBBELE HANDDOEKHOUDER DRAAIBAAR

240 01 75
\$ 2,580.00

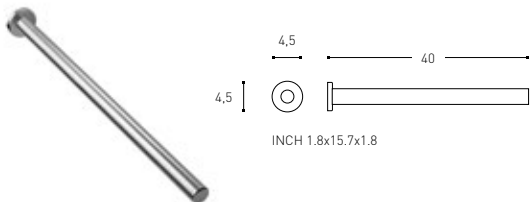

● TOALLERO
TOWEL RACK
PORTE - SERVIETTE
PORTASALVIETTE
TOALHEIRO
HANDTUCHSTANGE
HANDDOEKHOUDER

MX 205 01 69
\$ 1,010.00

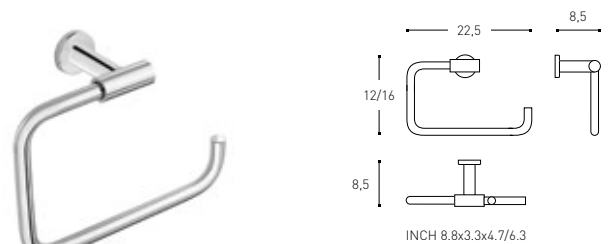

● TOALLERO ARO
TOWEL RING
PORTE - SERVIETTE ANNEAU
PORTASALVIETTE ANELLO
TOALHEIRO ARGOLA
HANDTUCHRING
HANDDOEKRING

MX 205 01 71 12 CM / INCH 4.7
\$ 1,300.00

NEW 205 01 71 D 12 CM / INCH 4.7
\$ 1,420.00

205 01 72 16 CM / INCH 6.3
\$ 1,370.00

NEW 205 01 72 D 16 CM / INCH 6.3
\$ 1,490.00

architect

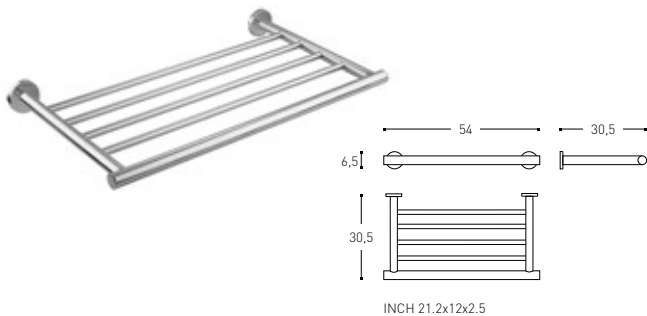

INCH 21.2x12x2.5

- TOALLERO ESTANTE
BRACKET - SHELF TOWEL RACK
PORTE - LINGE DE BAIN
PORTASALVIETTE MENSOLA
TOALHEIRO PRATELEIRA
HANDTUCHABLAGE
HANDDOEKREK

205 01 68
\$ 3,490.00

NEW 205 01 68 D
\$ 3,720.00

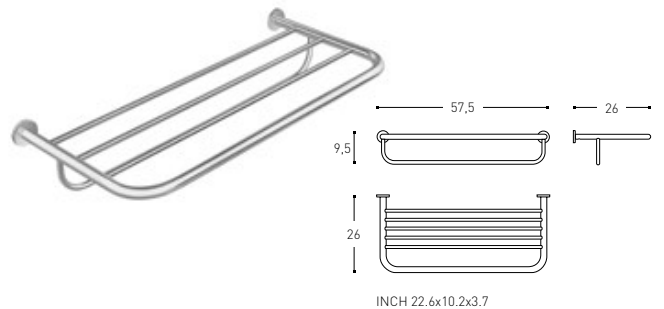

INCH 22.6x10.2x3.7

- TOALLERO ESTANTE
BRACKET - SHELF TOWEL RACK
PORTE - LINGE DE BAIN
PORTASALVIETTE MENSOLA
TOALHEIRO PRATELEIRA
HANDTUCHABLAGE
HANDDOEKREK

MX 290 01 68
\$ 3,130.00

NEW 290 01 68 D
\$ 3,720.00

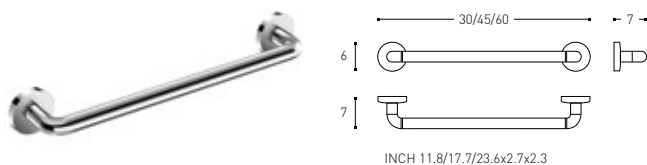

INCH 11.8/17.7/23.6x2.7x2.3

- ASA BAÑERA
GRAB BAR
POIGNÉE BAIGNOIRE
MANIGLIA VASCA
ASA BANHEIRA
WANNENGRIF
BADRAIL

290 02 10 30 CM / INCH 11.8
\$ 1,170.00

290 02 11 45 CM / INCH 17.7
\$ 1,330.00

290 02 12 60 CM / INCH 23.6
\$ 1,460.00

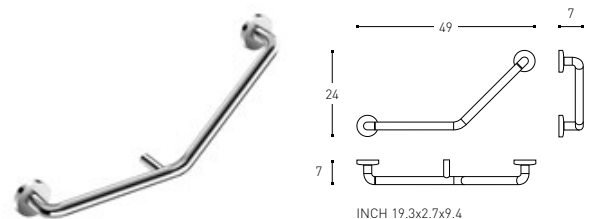

INCH 19.3x2.7x9.4

- ASA BAÑERA 135°
135° GRAB BAR
POIGNÉE BAIGNOIRE 135°
MANIGLIA VASCA 135°
ASA BANHEIRA 135°
WANNENGRIF 135°
BADRAIL 135°

290 02 13 DERECHA / RIGHT

\$ 3,130.00

290 02 14 IZQUIERDA / LEFT

\$ 3,130.00

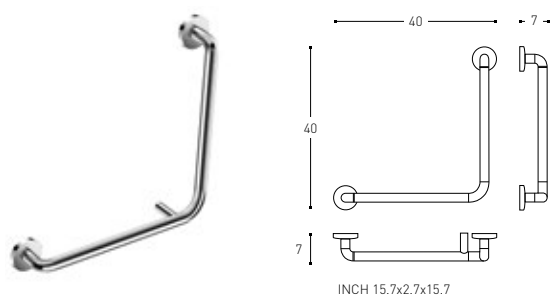

INCH 15.7x2.7x15.7

- ASA BAÑERA 90°
90° GRAB BAR
POIGNÉE BAIGNOIRE 90°
MANIGLIA VASCA 90°
ASA BANHEIRA 90°
WANNENGRIF 90°
BADRAIL 90°

290 02 15 DERECHA / RIGHT

\$ 3,290.00

290 02 16 IZQUIERDA / LEFT

\$ 3,290.00

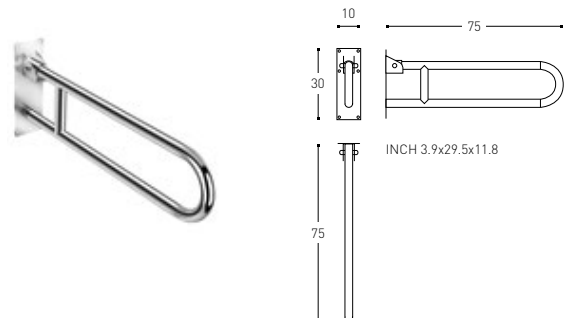

INCH 3.9x29.5x11.8

- ASA ABATIBLE
HINGED GRAB BAR
BARRE D'APPUI RELEVABLE
ASTA MOBILE PER DISABILI
BARRA BASCULANTE
KLAPPBARE HALTESCHIENE
OPKLAPBARE BEUGEL

290 02 17
\$ 7,000.00



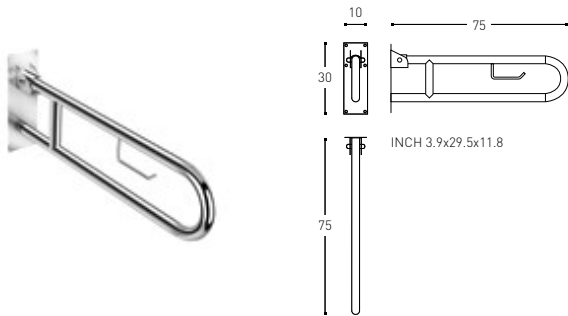

- ASA ABATIBLE CON PORTARROLLOS
HINGED GRAB BAR WITH PAPER HOLDER
BARRE D'APPUI RELEVABLE AVEC PORTEROLEAUX
ASTA MOBILE PER DISABILI CON PORTAROTOLO
BARRA BASCULANTE COM PORTA ROLOS
KLAPPBARE HALTESCHIENE MIT ROLLENHALTER
OPKLAPBARE BEUGEL MET WC-ROLHOUDER

290 02 18
\$ 7,000.00



- PORTAPAPEL CON TAPA
PAPER HOLDER WITH COVER
PORTE - ROULEAUX COUVERT
PORTAROTOLO CON COPERCHIO
PORTA - ROLO COM TAMPA
ROLLENHALTER MIT DECKEL
TOILETROLHOUDER MET KLEP

MX 205 01 59
\$ 1,370.00

NEW 205 01 59 D*
\$ 1,490.00



- PORTAPAPEL SIN TAPA
PAPER HOLDER WITHOUT COVER
PORTE - ROULEAUX SANS COUVERCLE
PORTAROTOLO SENZA COPERCHIO
PORTA - ROLO SEM TAMPA
ROLLENHALTER OHNE DECKEL
TOILETROLHOUDER ZONDER KLEP

MX 205 01 58
\$ 1,100.00

NEW 205 01 58 D
\$ 1,210.00

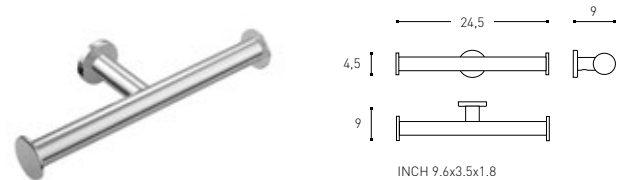

- PORTAPAPEL DOBLE SIN TAPA
DOUBLE PAPER HOLDER WITHOUT COVER
PORTE - ROULEAUX DOUBLE SANS COUVERCLE
PORTAROTOLO DOPPIO SENZA COPERCHIO
PORTA - ROLO DUPLO SEM TAMPA
DOPPELTER ROLLENHALTER OHNE DECKEL
DUBBELE TOILETROLHOUDER ZONDER KLEP

MX 205 01 57
\$ 1,240.00

NEW 205 01 57 D
\$ 1,370.00

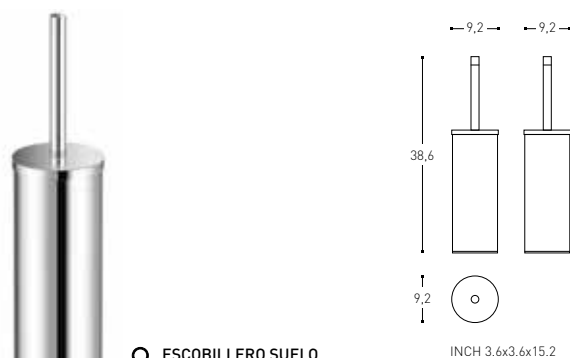

- ESCOBILLERO SUELO
FLOOR TOILET BRUSH
PORTE-BALAYETTE SOL
PORTASCPINO A TERRA
PORTA-PIACABA SOLO
TOILETTENBÜRSTENHALTER BODEN
WC-BORSTELHOUDER VLOER

NEW 290 02 24
\$ 1,300.00

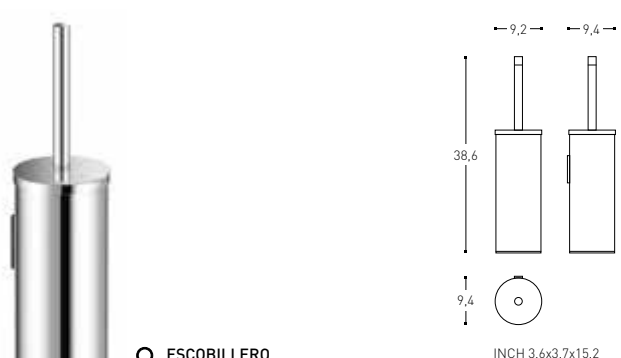

- ESCOBILLERO
TOILET BRUSH
PORTE-BALAYETTE
PORTASCPINO
PORTA-PIACABA
TOILETTENBÜRSTENHALTER
WC-BORSTELHOUDER

NEW 290 02 23
\$ 1,350.00

* SISTEMA FIJACIÓN ADHESIVO 3M
3M ADHESIVE MOUNTING SYSTEM
SYSTÈME DE FIXATION ADHÉSIF 3M
SISTEMA DI FISSAGGIO CON BIADESIVO 3M
SISTEMA DE FIXAÇÃO ADESIVO 3M
KLEBEBEFESTIGUNGSSYSTEM 3M
INSTALLATIE SYSTEEM MET PLAKBAND 3M

architect

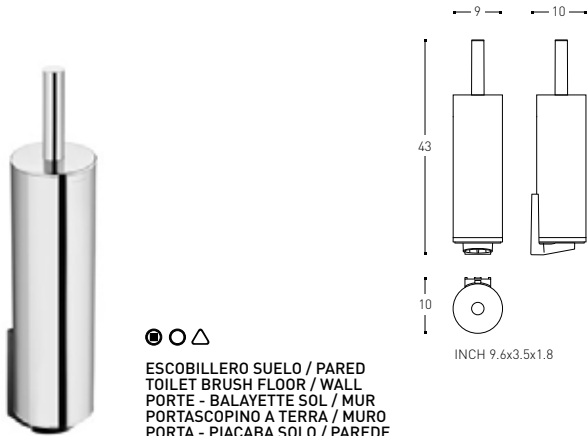

⊙ ○ △

ESCOBILLERO SUELO / PARED
TOILET BRUSH FLOOR / WALL
PORTE - BALAYETTE SOL / MUR
PORTASCOPINO A TERRA / MURO
PORTA - PIACABA SOLO / PAREDE
TOILETTENBÜRSTENHALTER BODEN / WAND
WC - BORSTELHOUDER VLOER / MUUR

251 01 00
\$ 2,720.00

NEW **251 01 00 D**
\$ 2,970.00

INCH 9.6x3.5x1.8

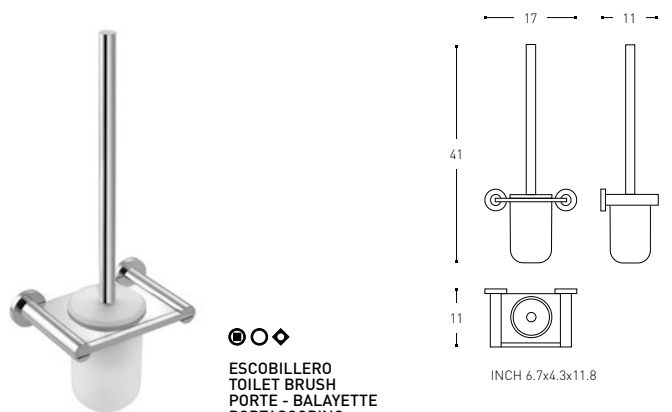

⊙ ○ ◆

ESCOBILLERO
TOILET BRUSH
PORTE - BALAYETTE
PORTASCOPINO
PORTA - PIACABA
TOILETTENBÜRSTENHALTER
WC-BORSTELHOUDER

MX **205 01 00**
\$ 1,740.00

NEW **205 01 00 D**
\$ 1,920.00

INCH 6.7x4.3x11.8



○ PAPELERA
WASTEBIN
POUBELLE
GETTACARTA
BALDE
ABFALLBEHÄLTER
PAPIERMAND

290 07 02 3 L.
\$ 590.00

290 07 03 5 L.
\$ 720.00

290 07 04 12 L.
\$ 1,070.00

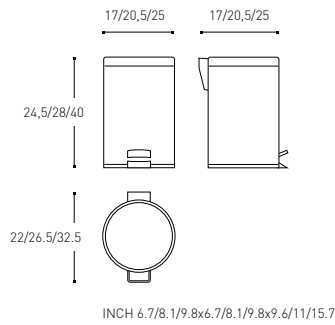

INCH 6.7/8.1/9.8x6.7/8.1/9.8x9.6/11/15.7

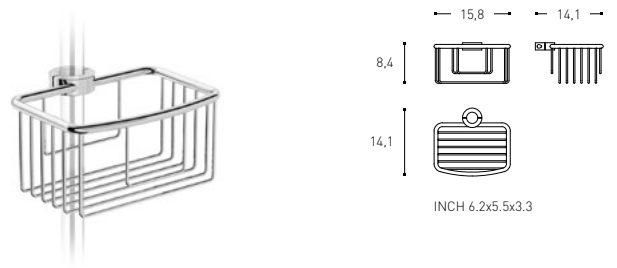

⊙ CONTAINER PARA BARRA DUCHA
BASKET FOR SHOWER BAR
PANIER POUR BARRE DE DOUCHE
CESTINO PER ASTA SALISCENDI PER DOCCIA
CONTAINER PARA BARRA DE DUCHE
SEIFENKORB FÜR DUSCHSTANGE
REKJE VOOR DOUCHE STAAN

290 01 33
\$ 2,170.00

INCH 6.2x5.5x3.3



⊙ △ ASIENTO DUCHA
SHOWER SEAT
BANQUETTE POUR DOUCHE
SGABELLO PER DOCCIA
ASSENTO DUCHE
SITZ FÜR DUSCH
WANDZIT VOOR DOUCHE

290 06 34
\$ 7,700.00

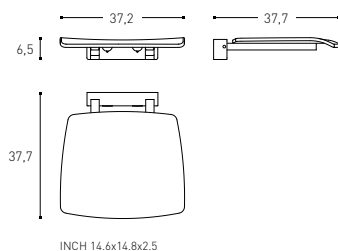

INCH 14.6x14.8x2.5



○ TENEDERO EXTENSIBLE
EXTENSIBLE CLOTHE-LINE
FIL À LINGE EXTENSIBLE
FILO ESTENSIBILE
ESTENDAL EXTENSIVEL
AUSZIEHBARE WÄSCHELEINE
UITSCHUIFBARE WASLIJN

290 02 19
\$ 1,260.00

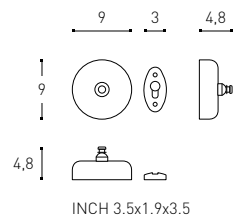

INCH 3.5x1.9x3.5

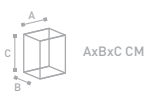

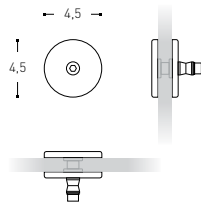
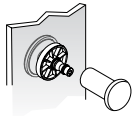

INCH 1.8x1.8

SOPORTE MAMPARA PARA COLGADOR
GLASS SHOWER ENCLOSURE HOLDER FOR HOOK
SUPPORT PAROI DE DOUCHE POUR PATÈRE
SUPPORTO PORTA DOCCIA PER APPENDINO
SOPORTE DIVISÓRIA PARA CABIDE
HALTERUNG DUSCHABTRENNUNG FÜR HAKEN
MUURBEUGEL DOUCHESCHERM VOOR HAKEN

MX 205 01 41
\$ 460.00

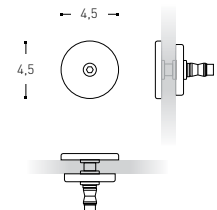
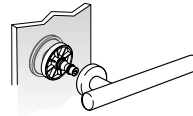

INCH 1.8x1.8

SOPORTE MAMPARA PARA TOALLERO
GLASS SHOWER ENCLOSURE HOLDER FOR TOWEL BAR
SUPPORT PAROI DE DOUCHE POUR PORTE-SERVIETTE
SUPPORTO PORTA DOCCIA PER PORTASALVIETTE
SOPORTE DIVISÓRIA PARA TOALHEIRO
HALTERUNG DUSCHABTRENNUNG FÜR HANDTUCHSTANGE
MUURBEUGEL DOUCHESCHERM VOOR HANDDOEKSTANG

MX 205 01 40
\$ 320.00

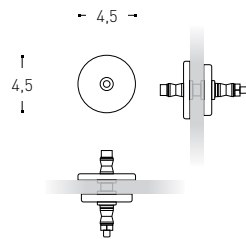
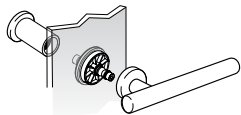

INCH 1.8x1.8

SOPORTE MAMPARA PARA TOALLERO / COLGADOR
GLASS SHOWER ENCLOSURE HOLDER FOR TOWEL BAR / HOOK
SUPPORT PAROI DE DOUCHE POUR PORTE-SERVIETTE / PATÈRE
SUPPORTO PORTA DOCCIA PER PORTASALVIETTE / APPENDINO
SOPORTE DIVISÓRIA PARA TOALHEIRO / CABIDE
HALTERUNG DUSCHABTRENNUNG FÜR HANDTUCHSTANGE / HAKEN
MUURBEUGEL DOUCHESCHERM VOOR HANDDOEKSTANG / HAKEN

MX 205 01 38
\$ 320.00

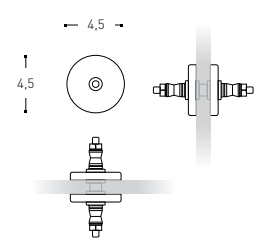
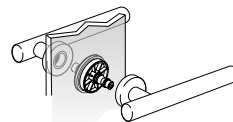

INCH 1.8x1.8

SOPORTE MAMPARA PARA TOALLERO / TOALLERO
GLASS SHOWER ENCLOSURE HOLDER FOR TOWEL BAR / TOWEL BAR
SUPPORT PAROI DE DOUCHE POUR PORTE-SERVIETTE / PORTE-SERVIETTE
SUPPORTO PORTA DOCCIA PER PORTASALVIETTE / PORTASALVIETTE
SOPORTE DIVISÓRIA PARA TOALHEIRO / TOALHEIRO
HALTERUNG DUSCHABTRENNUNG FÜR HANDTUCHSTANGE / HANDTUCHSTANGE
MUURBEUGEL DOUCHESCHERM VOOR HANDDOEKSTANG / HANDDOEKSTANG

205 01 42
\$ 600.00

architect

recambios spare parts pièces détachées ricambi peças de reposição ersatzteile reserveonderdelen

SOPORTE PARED COLGADOR / WALL MOUNTING SET HOOK / KIT FIXATION MURALE PATÈRE / ACCESSORIO FISSAGGIO A MURO APPENDINO / CONJUNTO SUPORTE PAREDE CABIDE / WANDFIXIERUNGSSSE HAKEN / MONTAGESSET WAND KLEDINGHAAK

341 06 71 \$ 100.00

RECAMBIO DE / SPARE PART OF / PIÈCE DÉTACHÉE DE / RICAMBIO DI / PEÇA DE REPOSIÇÃO DE / ERSATZTEIL FÜR / ONDERDEEL VAN 2050121

ACCESORIO SUJECIÓN PARED / WALL MOUNTING SET / KIT FIXATION MURALE / ACCESSORIO FISSAGGIO MURO / CONJUNTO FIXAÇÃO PAREDE / WANDFIXIERUNGSSSET / MONTAGESSET WAND

341 06 63 \$ 100.00

RECAMBIO DE / SPARE PART OF / PIÈCE DÉTACHÉE DE / RICAMBIO DI / PEÇA DE REPOSIÇÃO DE / ERSATZTEIL FÜR / ONDERDEEL VAN 2050121D, 2050157D, 2050158D, 2050161D, 2050164D, 2050165D, 2050166D, 2050167D, 2050171D

SOPORTE PARED JABONERA, PORTAVASO, ESTANTE, ESCOBILLERO / WALL MOUNTING SET SOAP DISH, GLASS, BRUSH-HOLDER, TOILET BRUSH / KIT FIXATION MURALE PORTE-SAVON, PORTE-BROSSE, VERRE, PORTE-BALAY / ACCESSORIO FISSAGGIO A MURO PORTASAP, PORTASPAZZO, BICCHIE, PORTASC. / CONJUNTO SUPORTE PAREDE SABONETEIRA, PORTA-COPPO, PORTA-PIAÇABA / WANDFIXIERUNGSSSE EIFENSCHALE, ZAHNBÜRSTENHALTER, BECHER, TOILETTENBÜR / MONTAGESSET WAND ZEEPBAKJE, BEKERHOUDER, WC-BORSTELHOUDER

341 06 67 \$ 100.00

RECAMBIO DE / SPARE PART OF / PIÈCE DÉTACHÉE DE / RICAMBIO DI / PEÇA DE REPOSIÇÃO DE / ERSATZTEIL FÜR / ONDERDEEL VAN 2050100D, 2050132D, 2050133D, 2050144D, 2050145D, 2050146D, 2050152D

SOPORTE PARED DOSIFICADOR Y VASO / WALL MOUNTING SET SOAP DISPENSER, TUMBLER / KIT FIXATION MURALE PORTE-SAVON LIQUIDE, VERRE / ACCESSORIO FISSAGGIO A MURO DISPENSER, BICCHIERE / CONJUNTO SUPORTE PAREDE DOSEADOR SABONETE, COPO / WANDFIXIERUNGSSSE EIFENSPENDER, ZAHNPUTZBECHER / MONTAGESSET WAND DOSEERDER, BEKER

341 06 73 \$ 230.00

RECAMBIO DE / SPARE PART OF / PIÈCE DÉTACHÉE DE / RICAMBIO DI / PEÇA DE REPOSIÇÃO DE / ERSATZTEIL FÜR / ONDERDEEL VAN 2050103D, 2050153D

ACCESORIO SUJECIÓN PARED / WALL MOUNTING SET / KIT FIXATION MURALE / ACCESSORIO FISSAGGIO MURO / CONJUNTO FIXAÇÃO PAREDE / WANDFIXIERUNGSSSET / MONTAGESSET WAND

341 06 14 Cromo / Chrome / Chrome / Cromo / Cromo / Chrom / Verchromd \$ 590.00

RECAMBIO DE / SPARE PART OF / PIÈCE DÉTACHÉE DE / RICAMBIO DI / PEÇA DE REPOSIÇÃO DE / ERSATZTEIL FÜR / ONDERDEEL VAN 2400175, 2050169

341 06 69 \$ 230.00

RECAMBIO DE / SPARE PART OF / PIÈCE DÉTACHÉE DE / RICAMBIO DI / PEÇA DE REPOSIÇÃO DE / ERSATZTEIL FÜR / ONDERDEEL VAN 2050168D, 2900168D

341 06 63 \$ 100.00

RECAMBIO DE / SPARE PART OF / PIÈCE DÉTACHÉE DE / RICAMBIO DI / PEÇA DE REPOSIÇÃO DE / ERSATZTEIL FÜR / ONDERDEEL VAN 2050168, 2050169

ACCESORIO SOPORTE PARED DOBLE ASA / GRAB BAR DOUBLE WALL SUPPORT SET / SUPPORT MURAL DOUBLE POIGNÉE / ACCESSORIO SUPPORTO A MURO DOPPIO MANIGLIA VASCA / CONJUNTO SUPORTE PAREDE DUPLA ASA BANHEIRA / DOPPELTHE WANDFIXIERUNG FÜR WANNENGRIF / DUBBELE MONTAGESSET WAND VAN BADRAIL

341 06 32 \$ 340.00

RECAMBIO DE / SPARE PART OF / PIÈCE DÉTACHÉE DE / RICAMBIO DI / PEÇA DE REPOSIÇÃO DE / ERSATZTEIL FÜR / ONDERDEEL VAN 2900210, 2900211, 2900212, 2900213, 2900214, 2900215, 2900216

CONJUNTO SUJECIÓN PARED ASA / GRAB BAR MOUNTING SET / KIT FIXATION MURALE POIGNÉE / KIT FISSAGGIO A MURO MANIGLIA VASCA / CONJUNTO FIXAÇÃO PAREDE ASA BANHEIRA / MONTAGESSET FÜR WANNENGRIF / MONTAGESSET BADRAIL

341 06 33 \$ 240.00

RECAMBIO DE / SPARE PART OF / PIÈCE DÉTACHÉE DE / RICAMBIO DI / PEÇA DE REPOSIÇÃO DE / ERSATZTEIL FÜR / ONDERDEEL VAN 2900213, 2900214, 2900215, 2900216

SOPORTE PARED ASA ABATIBLE / HINGED GRAB BAR WALL SUPPORT SET / SUPPORT MURAL BARRE D'APPUI RELEVABLE / ACCESSORIO SUPPORTO A MURO ASTA MOBILE PER DISABILI / CONJUNTO SUPORTE PAREDE BARRA BASCULANTE / WANDFIXIERUNGSSSET FÜR KLAPBARE HALTESCHIENE / MONTAGESSET WAND VAN OPKLAPBARE BEUGEL

341 06 34 \$ 380.00

RECAMBIO DE / SPARE PART OF / PIÈCE DÉTACHÉE DE / RICAMBIO DI / PEÇA DE REPOSIÇÃO DE / ERSATZTEIL FÜR / ONDERDEEL VAN 2900217, 2900218

ACCESORIO SUJECIÓN PARED / WALL MOUNTING SET / KIT FIXATION MURALE / ACCESSORIO FISSAGGIO MURO / CONJUNTO FIXAÇÃO PAREDE / WANDFIXIERUNGSSSET / MONTAGESSET WAND

341 06 28 \$ 200.00

RECAMBIO DE / SPARE PART OF / PIÈCE DÉTACHÉE DE / RICAMBIO DI / PEÇA DE REPOSIÇÃO DE / ERSATZTEIL FÜR / ONDERDEEL VAN 2900220

341 06 49 Inox Brillo / Glossy Inox / Inox Brillant / Inox Lucido / Inox Brilho / Edeldstahl Glänzend / Glanzend Roestvrij Staal \$ 260.00

RECAMBIO DE / SPARE PART OF / PIÈCE DÉTACHÉE DE / RICAMBIO DI / PEÇA DE REPOSIÇÃO DE / ERSATZTEIL FÜR / ONDERDEEL VAN 2900223

KIT SMARTFIX + SOPORTE DOSIFICADOR, VASO / KIT SMARTFIX+WALL MOUNTING SET SOAP DISPENSER, TUMBLER / KIT SMARTFIX+KIT FIXATION MURALE PORTE-SAVON LIQUIDE, VERRE / KIT SMARTFIX+ACCESSORIO FISSAGGIO A MURO DISPENSER, BICCHIERE / KIT SMARTFIX+CONJUNTO SUPORTE PAREDE DOSEADOR SABONETE, COPO / KIT SMARTFIX+ WANDFIXIERUNGSSSE EIFENSPENDER, ZAHNPUTZBECHER / KIT SMARTFIX+MONTAGESSET WAND DOSEERDER, BEKER

341 06 81 \$ 570.00

RECAMBIO DE / SPARE PART OF / PIÈCE DÉTACHÉE DE / RICAMBIO DI / PEÇA DE REPOSIÇÃO DE / ERSATZTEIL FÜR / ONDERDEEL VAN 2050100

SOPORTE PARED ESCOBILLERO / WALL MOUNTING SET TOILET BRUSH / KIT FIXATION MURALE PORTE-BALAYETTE / ACCESSORIO FISSAGGIO A MURO PORTASOPINO / CONJUNTO SUPORTE PAREDE PORTA-PIAÇABA / WANDFIXIERUNGSSSE TOILETTENBÜRSTENHALTER / MONTAGESSET WAND WC-BORSTELHOUDER

341 06 66 \$ 160.00

RECAMBIO DE / SPARE PART OF / PIÈCE DÉTACHÉE DE / RICAMBIO DI / PEÇA DE REPOSIÇÃO DE / ERSATZTEIL FÜR / ONDERDEEL VAN 2510100D

KIT SMARTFIX+2 SOPORTES TOALLEROS / KIT SMARTFIX+ 2 WALL MOUNTING SET TOWEL BAR / KIT SMARTFIX+2 KIT FIXATION MURALE PORTE-SERVETTE / KIT SMARTFIX+ 2 ACCESSORIO FISSAGGIO A MURO PORTASALVIETTE / KIT SMARTFIX+ 2 CONJUNTO SUPORTE PAREDE TOALHEIRO / KIT SMARTFIX+2 WANDFIXIERUNGSSSE HANDTUCHHALTER / KIT SMARTFIX+2 MONTAGESSET WAND HANDDOEKHOUDER

341 06 77 \$ 480.00

RECAMBIO DE / SPARE PART OF / PIÈCE DÉTACHÉE DE / RICAMBIO DI / PEÇA DE REPOSIÇÃO DE / ERSATZTEIL FÜR / ONDERDEEL VAN 2050100

KIT SMARTFIX + SOPORTE ARO, PORTAPAPEL ST / KIT SMARTFIX+WALL MOUNTING SE TOWEL RING, PAPER HOLDER WITHOUT COVER / KIT SMARTFIX+KIT FIXATION MURALE ANNEAU, PORTE-ROULEAUX SANS COUVERCLE / KIT SMARTFIX+ACCESSORIO FISSAGGIO A MURO ANELO, PORTAROTOLO S COPER. / KIT SMARTFIX+CONJUNTO SUPORTE PAREDE ARGOLA, PORTA-ROLO SEM TAMPA / KIT SMARTFIX+WANDFIXIERUNGSSSE HANDTUCHRING, ROLLENHALTER OHNE DECKEL / KIT SMARTFIX+MONTAGESSET WAND HANDDOEKRING, TOILETROLHOUDER ZONDER KLEP

341 06 78 \$ 440.00

RECAMBIO DE / SPARE PART OF / PIÈCE DÉTACHÉE DE / RICAMBIO DI / PEÇA DE REPOSIÇÃO DE / ERSATZTEIL FÜR / ONDERDEEL VAN 2050100

KIT SMARTFIX + SOPORTE JABONERA, PORTAVASO ESTANTES, ESCOBILLERO / KIT SMARTFIX + WALL MOUNTING SET SOAP DISH, BRUSH-HOLDER, TOILET BRUSH / KIT SMARTFIX+ FIXATION MURALE PORTE-SAVON, PORTE-BROSSE, PORTE-BALAY. / KIT SMARTFIX +ACCESSORIO FISSAGGIO PORTASAP, PORTAS., BICCHIERE, PORTAS. / KIT SMARTFIX + SUPORTE PAREDE SABONETEIRA, PORTA-COPPO, PORTA-PIAÇABA / KIT SMARTFIX + WANDFIXIERUNGSSSE SEIFENS., ZAHNBÜR., BECHER, TOILETTENBÜ. / KIT SMARTFIX + MONTAGESSET WAND ZEEPBAKJE, BEKERHOUDER, WC-BORSTE.

341 06 80 \$ 440.00

RECAMBIO DE / SPARE PART OF / PIÈCE DÉTACHÉE DE / RICAMBIO DI / PEÇA DE REPOSIÇÃO DE / ERSATZTEIL FÜR / ONDERDEEL VAN 2050100

KIT SMARTFIX + SOPORTE ESCOBILLERO / KIT SMARTFIX + WALL MOUNTING SET TOILET BRUSH / KIT SMARTFIX + KIT FIXATION MURALE PORTE-BALAYETTE / KIT SMARTFIX + ACCESSORIO FISSAGGIO A MURO PORTASOPINO / KIT SMARTFIX +CONJUNTO SUPORTE PAREDE PORTA-PIAÇABA / KIT SMARTFIX + WANDFIXIERUNGSSSE TOILETTENBÜRSTENHALTER / KIT SMARTFIX + MONTAGESSET WAND WC-BORSTELHOUDER

341 06 79 \$ 480.00

RECAMBIO DE / SPARE PART OF / PIÈCE DÉTACHÉE DE / RICAMBIO DI / PEÇA DE REPOSIÇÃO DE / ERSATZTEIL FÜR / ONDERDEEL VAN 2050100

KIT SMARTFIX TOALLERO ARO, PORTAPAPEL ST / KIT SMARTFIX TOWEL RING, PAPER HOLDER WITHOUT COVER / KIT SMARTFIX PORTE-SERVETTE ANNEAU, PORTE-ROULEAUX SANS COUVERCLE / KIT SMARTFIX PORTASALVIETTE ANELLO, PORTAROTOLO SENZA COPERCHIO / KIT SMARTFIX TOALHEIRO ARGOLA, PORTAROLO SEM TAMPA / KIT SMARTFIX HANDTUCHRING, ROLLENHALTER OHNE DECKEL / KIT SMARTFIX HANDDOEKRING, TOILETROLHOUDER ZONDER KLEP

341 06 64 \$ 440.00
 RECAMBIO DE / SPARE PART OF / PIÈCE DÉTACHÉE DE / RICAMBIO DI / PEÇA DE REPOSIÇÃO DE / ERSATZTEIL FÜR / ONDERDEEL VAN
 2050121D, 2050157D, 2050158D, 2050161D, 2050164D, 2050165D, 2050166D, 2050167D, 2050171D

KIT SMARTFIX JABONERA, PORTAVASO ESTANTE, ESCOBILLERO / KIT SMARTFIX SOAP DISH, GLASS, BRUSH-HOLDER, TOILET BRUSH / KIT SMARTFIX PORTE-SAVON, PORTE-BROSSE À DENTS, VERRE, PORTE-BALAYETTE / KIT SMARTFIX PORTASAPONE, PORTASPAZZOLINI, BICCHIERE, PORTASCOPINO / KIT SMARTFIX SABONETEIRA, PORTA-COPPO, PORTA-PIAÇABA / KIT SMARTFIX SEIFENSCHALE, ZAHNBÜRSTENHALTER, TOILETTENBÜRSTENHALTER / KIT SMARTFIX ZEEPBAKJE, BEKERHOUDER, WC-BORSTELHOUDER

341 06 68 \$ 440.00
 RECAMBIO DE / SPARE PART OF / PIÈCE DÉTACHÉE DE / RICAMBIO DI / PEÇA DE REPOSIÇÃO DE / ERSATZTEIL FÜR / ONDERDEEL VAN
 2050100D, 2050132D, 2050133D, 2050144D, 2050145D, 2050146D, 2050152D

KIT SMARTFIX DOSIFICADOR, VASO / KIT SMARTFIX SOAP DISPENSER, TUMBLER / KIT SMARTFIX PORTE-SAVON LIQUIDE, VERRE / KIT SMARTFIX DISPENSER, BICCHIERE / KIT SMARTFIX DOSEADOR SABONETE, COPO / KIT SMARTFIX SEIFENSPENDER, ZAHNPUTZBECHER / KIT SMARTFIX DOSEERDER, BEKER

341 06 74 \$ 570.00
 RECAMBIO DE / SPARE PART OF / PIÈCE DÉTACHÉE DE / RICAMBIO DI / PEÇA DE REPOSIÇÃO DE / ERSATZTEIL FÜR / ONDERDEEL VAN
 2050103D, 2050153D

KIT SMARTFIX TOALLERO ESTANTE / KIT SMARTFIX TOWEL RACK SHELF / KIT SMARTFIX PORTE-SERVETTE TABLETTE / KIT SMARTFIX PORTASALVIETTE MENSOLA / KIT SMARTFIX TOALHEIRO PRATELEIRA / KIT SMARTFIX HANDTUCHSTABLAG / KIT SMARTFIX HANDDOEKHOUDER REK

341 06 70 \$ 370.00
 RECAMBIO DE / SPARE PART OF / PIÈCE DÉTACHÉE DE / RICAMBIO DI / PEÇA DE REPOSIÇÃO DE / ERSATZTEIL FÜR / ONDERDEEL VAN
 2050168D, 2900168D

KIT ADHESIVO PORTAPAPEL C TAPA / ADHESIVE KIT PAPER HOLDER WITH COVER / KIT ADHESIVO PORTE-ROULEAUX AVEC COUVERCLE / KIT ADESIVO PORTAROTOLO CON COPERCHIO / KIT ADESIVO PORTA-ROLO COM TAMPA / KLEBESET ROLLENHALTER MIT DECKEL / ADHESIVE KIT TOILETROLHOUDER MET KLEP

341 06 72 \$ 370.00
 RECAMBIO DE / SPARE PART OF / PIÈCE DÉTACHÉE DE / RICAMBIO DI / PEÇA DE REPOSIÇÃO DE / ERSATZTEIL FÜR / ONDERDEEL VAN
 2050159D

KIT SMARTFIX ESCOBILLERO / KIT SMARTFIX TOILET BRUSH / KIT SMARTFIX PORTE-BALAYETTE / KIT SMARTFIX PORTASCOPINO / KIT SMARTFIX PORTA-PIAÇABA / KIT SMARTFIX TOILETTENBÜRSTENHALTER / KIT SMARTFIX WC-BORSTELHOUDER

341 06 65 \$ 480.00
 RECAMBIO DE / SPARE PART OF / PIÈCE DÉTACHÉE DE / RICAMBIO DI / PEÇA DE REPOSIÇÃO DE / ERSATZTEIL FÜR / ONDERDEEL VAN
 2510100D

VASO / GLASS / VERRE / BICCHIERE / COPO / ZAHNPUTZBECHER / BEKER

330 27 31 Mate / Matte / Mat / Satinato / Mate / Matt / Mat \$ 300.00
 RECAMBIO DE / SPARE PART OF / PIÈCE DÉTACHÉE DE / RICAMBIO DI / PEÇA DE REPOSIÇÃO DE / ERSATZTEIL FÜR / ONDERDEEL VAN
 2050152

PULSADOR + BOMBA DOSIFICADOR / DISPENSER PUSH BUTTON + PUMP / POUSSOIR + POMPE PORTE-SAVON LIQUIDE / PULSANTE + POMPETTA DISPENSER / BOTÃO + BOMBA DOSEADOR / PUMPENKOPF FÜR SEIFENSPENDER / DRUKKNOP + POMP VERDELER VLOEIBARE ZEEP

341 06 15 \$ 310.00
 RECAMBIO DE / SPARE PART OF / PIÈCE DÉTACHÉE DE / RICAMBIO DI / PEÇA DE REPOSIÇÃO DE / ERSATZTEIL FÜR / ONDERDEEL VAN
 2050103, 2050104

BOMBA DOSIFICADOR / DISPENSER PUMP / POMPE PORTE-SAVON LIQUIDE / POMPETTA DISPENSER / BOMBA DISPENSADOR / DOSIERPUMPE SEIFENSPENDER / DOSEERPOMPJE

341 06 22 \$ 140.00
 RECAMBIO DE / SPARE PART OF / PIÈCE DÉTACHÉE DE / RICAMBIO DI / PEÇA DE REPOSIÇÃO DE / ERSATZTEIL FÜR / ONDERDEEL VAN
 2050103, 2050104

ESTANTE / SHELF / TABLETTE / MENSOLA / PRATELEIRA / ABLAGE / REK

40 CM / INCH 15.7
 330 35 30 Mate / Matte / Mat / Satinato / Mate / Matt / Mat \$ 630.00
 RECAMBIO DE / SPARE PART OF / PIÈCE DÉTACHÉE DE / RICAMBIO DI / PEÇA DE REPOSIÇÃO DE / ERSATZTEIL FÜR / ONDERDEEL VAN
 2050144

57,5 CM / INCH 22.6
 330 31 30 Mate / Matte / Mat / Satinato / Mate / Matt / Mat \$ 1,350.00
 RECAMBIO DE / SPARE PART OF / PIÈCE DÉTACHÉE DE / RICAMBIO DI / PEÇA DE REPOSIÇÃO DE / ERSATZTEIL FÜR / ONDERDEEL VAN
 2050145

EJE PORTAPAPEL / CROSS AXIS PAPER HOLDER / AXE PORTE-ROULEAUX / ASSE PORTAROTOLO / EJE PORTA ROLLO / QUERACHSE ROLLENHALTER / HAAKSE TOILETROLHOUDER

350 06 00 \$ 160.00
 RECAMBIO DE / SPARE PART OF / PIÈCE DÉTACHÉE DE / RICAMBIO DI / PEÇA DE REPOSIÇÃO DE / ERSATZTEIL FÜR / ONDERDEEL VAN
 2050159

VASO ESCOBILLERO / TOILET BRUSH GLASS / VERRE PORTE-BALAYETTE / BICCHIERE PORTASCOPINO / COPO PORTA-PIAÇABA / GLAS TOILETTENBÜRSTENHALTER / WC-BORSTELHOUDERPOT

330 83 00 Mate / Matte / Mat / Satinato / Mate / Matt / Mat \$ 500.00
 RECAMBIO DE / SPARE PART OF / PIÈCE DÉTACHÉE DE / RICAMBIO DI / PEÇA DE REPOSIÇÃO DE / ERSATZTEIL FÜR / ONDERDEEL VAN
 2050100

PALO ESCOBILLERO CON CEPILLO / TOILET BRUSH STICK WITH BRUSH / MANCHE BALAYETTE AVEC BROSSE / MANICO SCOPINO CON SPAZZOLINO / ESCOVA COM CABO PORTA-PIAÇABA / TOILETTENBÜRSTE MIT GRIFF / HANDVAT MET BORSTEL

340 04 01 \$ 700.00
 RECAMBIO DE / SPARE PART OF / PIÈCE DÉTACHÉE DE / RICAMBIO DI / PEÇA DE REPOSIÇÃO DE / ERSATZTEIL FÜR / ONDERDEEL VAN
 2050100

340 90 17 \$ 840.00
 RECAMBIO DE / SPARE PART OF / PIÈCE DÉTACHÉE DE / RICAMBIO DI / PEÇA DE REPOSIÇÃO DE / ERSATZTEIL FÜR / ONDERDEEL VAN
 2510100

341 06 48 \$ 730.00
 RECAMBIO DE / SPARE PART OF / PIÈCE DÉTACHÉE DE / RICAMBIO DI / PEÇA DE REPOSIÇÃO DE / ERSATZTEIL FÜR / ONDERDEEL VAN
 2900223, 2900224

CEPILLO ESCOBILLERO / TOILET BRUSH BRUSH / BROSSE PORTE-BALAYETTE / SPAZZOLINO PORTASCOPINO / ESCOVA PARA PIAÇABA / TOILETTENBÜRSTENKOPF / BORSTEL WC-BORSTELHOUDER

350 11 00 Blanco / White / Blanc / Bianco / Branco / Weiss / Wit \$ 280.00
 341 03 13 Negro / Black / Noir / Nero / Preto / Schwarz / Zwart \$ 280.00
 RECAMBIO DE / SPARE PART OF / PIÈCE DÉTACHÉE DE / RICAMBIO DI / PEÇA DE REPOSIÇÃO DE / ERSATZTEIL FÜR / ONDERDEEL VAN
 2050100, 2510100

341 06 47 Negro / Black / Noir / Nero / Preto / Schwarz / Zwart \$ 300.00
 RECAMBIO DE / SPARE PART OF / PIÈCE DÉTACHÉE DE / RICAMBIO DI / PEÇA DE REPOSIÇÃO DE / ERSATZTEIL FÜR / ONDERDEEL VAN
 2900223, 2900224

JUEGO BIS SUJECIÓN (M5/M6) / SCREW MOUNTING SET (M5/M6) / SET VIS FIXATION (M5/M6) / KIT VITE FISSAGGIO (M5/M6) / CONJUNTO BIS FIXAÇÃO (M5/M6) / MADENSCHRAUBENSET (M5/M6) / MONTAGESET (M5/M6)

330 91 00 \$ 60.00

TACO PLADUR / DRYWALL ANCHOR / CHEVILLE PLACOPLÂTRE / TASSELLO CARTONGESSO / TACO PLADUR / DÜBEL FÜR RIGIPS-PLATTEN / GIPSPLAAT PLUG

341 06 36 \$ 150.00
 RECAMBIO DE / SPARE PART OF / PIÈCE DÉTACHÉE DE / RICAMBIO DI / PEÇA DE REPOSIÇÃO DE / ERSATZTEIL FÜR / ONDERDEEL VAN
 2050100, 2050103, 2050120, 2050122, 2050132, 2050133, 2050144, 2050145, 2050146, 2050152, 2050153, 2050157, 2050158, 2050159, 2050161, 2050164, 2050165, 2050166, 2050167, 2050168, 2050169, 2050171, 2050172, 2900168, 2900210, 2900211, 2900212, 2900213, 2900214, 2900215, 2900216, 2900230, 2900239



Conjugación de **líneas**
y **ángulos** rectos perfectos,
de diseño **exclusivo**
y **atemporal**.

*Set of perfectly straight
lines and angles
within an exclusive
and timeless design.*



batht life

DESIGN BY CARLES FERRUZ

bath life



Características

Fácil instalación: tornillo de doble paso.
Fijaciones ocultas. Anticorrosión.

Features

*Easy installation: double pitch screw.
Hidden attachments. Anti-corrosion.*

Caractéristiques :

Facile installation : vis à double pas.
Fixations occultes. Anti-corrosion.

Caratteristiche:

*Facile installazione : vite a doppio passo.
Fissaggio nascosto. Anticorrosivo.*

Características:

Fácil instalação: parafuso de dupla
passagem. Fixações ocultas.
Anti-corrosão.

Eigenschaften:

*Einfache montage: doppel-pass-schraube.
Unsichtbare Befestigungen.
Korrosionsschutz.*

Kenmerken:

Eenvoudig te monteren: schroef met
dubbele draad. Verborgen bevestigingen.
Corrosiewerend.

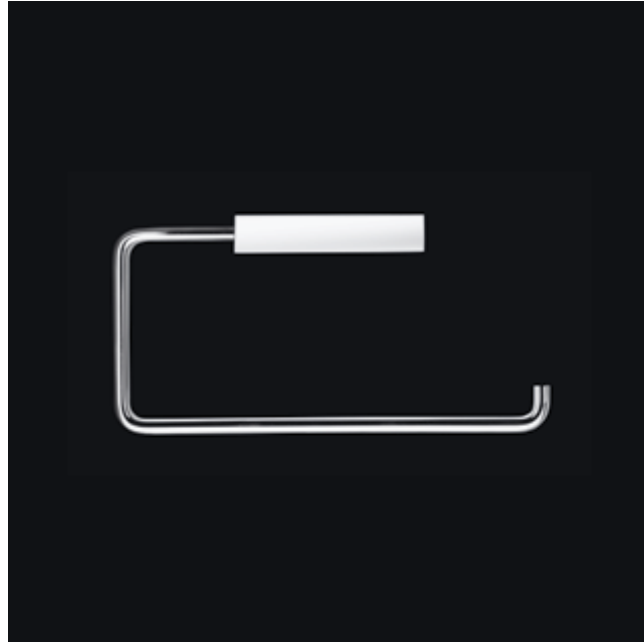

Acabados

Finishes

Finitions

Finiture

Acabamentos

Oberflächen

Afwerkingen

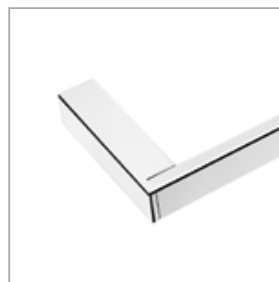

01

Cromo
Chrome
Chromé
Cromo
Cromo
Chrom
Verchromd



Blanco
White
Blanc
Bianco
Branco
Weiss
Wit

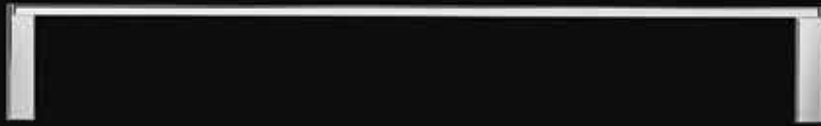
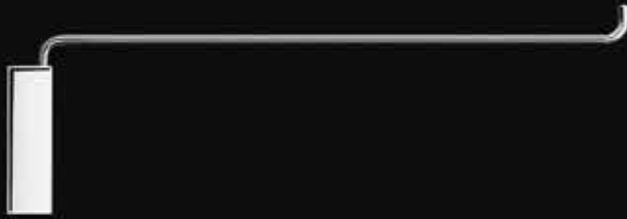

bath life



INCH 0.8x0.8x2.7

- COLGADOR
HANGER
PATÈRE
APPENDINO
CABIDE
HAKEN
KLEERHAAK

MX 229 01 21
\$ 770.00

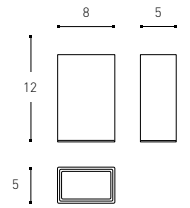

INCH 3.1x2.8x4.7

- PORTACEPILLOS ENCIMERA
FREE STANDING BRUSH-HOLDER
PORTE-BROSSE À DENTS À POSER
PORTASPAZZOLINI DA APPOGGIO
PORTA-ESCOVA DE DENTES DE BANCADA
ZAHNBÜRSTENHALTER FÜR AUFLAGE
TANDENBORSTELHOUDER VOOR BLAD

229 01 51
\$ 1,670.00

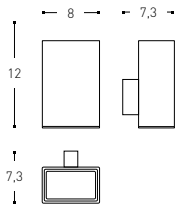

INCH 3.1x1.9x4.7

- PORTACEPILLOS
BRUSH-HOLDER
PORTE-BROSSE À DENTS
PORTASPAZZOLINI
PORTA-ESCOVA DE DENTES
ZAHNBÜRSTENHALTER
TANDENBORSTELHOUDER

MX 229 01 52
\$ 1,830.00

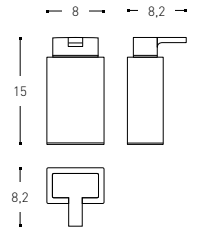

INCH 3.1x3.2x5.9

- DOSIFICADOR ENCIMERA
FREE STANDING SOAP DISPENSER
PORTE-SAVON LIQUIDE À POSER
DISPENSER DA APPOGGIO
DISPENSADOR SABONETE DE BANCADA
AUFLAGESEIFENSPENDER
DOSEERDER VOOR BLAD

229 01 04
\$ 2,280.00

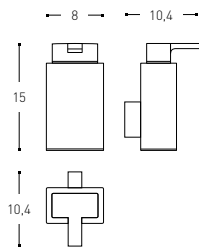

INCH 3.1x4x5.9

- DOSIFICADOR
SOAP DISPENSER
PORTE-SAVON LIQUIDE
DISPENSER
DISPENSADOR SABONETE
SEIFENSPENDER
DOSEERDER

MX 229 01 05
\$ 2,560.00

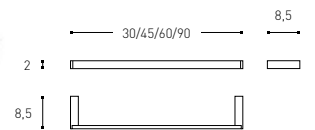

INCH 11.8/17.7/23.6/35.4x3.3x0.8

- TOALLERO
TOWEL RACK
PORTE-SERVLETTE
PORTASALVIETTE
TOALHEIRO
HANDTUCHSTANGE
HANDDOEKHOUDER

MX 229 01 63 30 CM / INCH 11.8
\$ 1,650.00

MX 229 01 64 60 CM / INCH 23.6
\$ 2,240.00

MX 229 01 69 45 CM / INCH 17.7
\$ 2,010.00

MX 229 01 65 90 CM / INCH 35.4
\$ 3,080.00



AxBxC CM

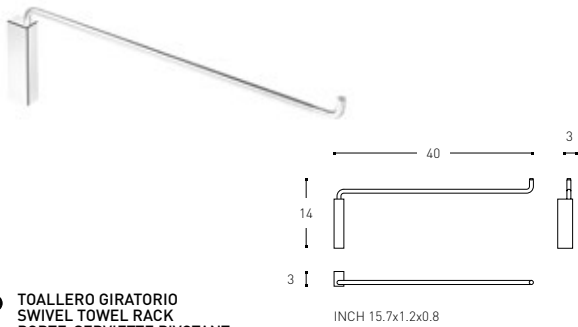

TOALLERO GIRATORIO
SWIVEL TOWEL RACK
PORTE-SERVIETTE PIVOTANT
PORTASALVIETTE A SNODO
TOALHEIRO GIRATÓTIO
HANDTUCHSTANGE SCHWENKBAR
HANDDOEKHOUDER DRAAIBAAR

229 01 74
\$ 1,780.00

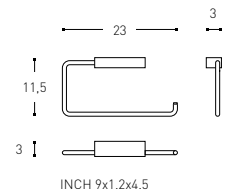

TOALLERO ARO
TOWEL RING
PORTE-SERVIETTE ANNEAU
PORTASALVIETTE ANELO
TOALHEIRO ARGOLA
HANDTUCHRING
HANDDOEKRING

229 01 71
\$ 1,620.00

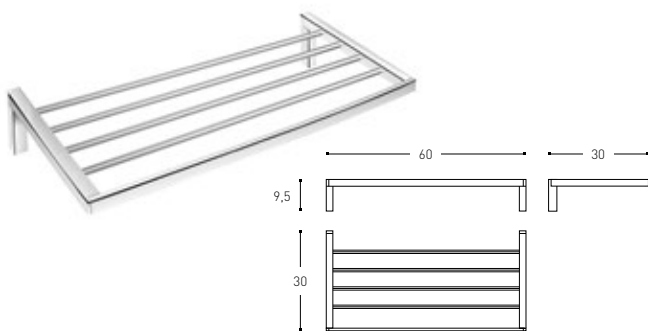

TOALLERO ESTANTE
BRACKET-SHELF TOWEL RACK
PORTE-LINGE DE BAIN
PORTASALVIETTE MENSOLA
TOALHEIRO PRATELEIRA
HANDTUCHABLAGE
HANDDOEKREK

229 01 68
\$ 6,100.00

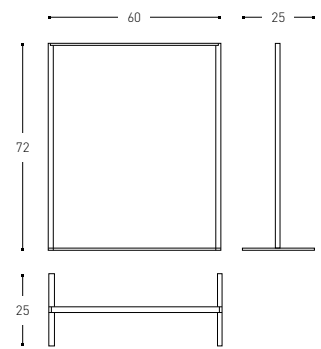

TOALLERO PIE
FLOOR STANDING TOWEL RACK
PORTE-SERVIETTE SUR PIED
PIANTANA
TOALHEIRO DE PIE
HANDTUCHSTÄNDER
HANDDOEKHOUDER MET VOET

229 01 66 60 CM / INCH 23.6
\$ 7,800.00



△ BANDEJA
DISH
COUPELLE
VASSOIO
BANDEJA
SCHALE
SCHAAL

229 05 33
\$ 420.00



△ PORTAOBJETOS
CONTAINER
PORTE - OBJETS
PORTA - OGGETTI
PORTA - OBJECTOS
BEHÄLTER
VOORWERPEN HOUDER

229 05 53
\$ 840.00

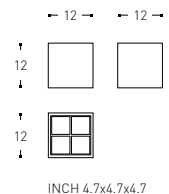

bath life

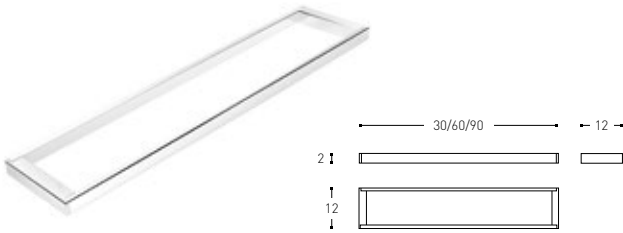

BARRA ESTANTE
 FLAT SHELF RACK
 BARRE ÉTAGÈRE
 SBARRA MENSOLA
 BARRA PRATELEIRA
 RAHMEN FÜR ABLAGE
 HANDDOEKREK

INCH 11.8/23.6/35.4x4.7x0.8

- MX** 229 01 40 30 CM / INCH 11.8 \$ 2,170.00
- MX** 229 01 60 60 CM / INCH 23.6 \$ 3,060.00
- 229 01 70 90 CM / INCH 35.4 \$ 3,900.00

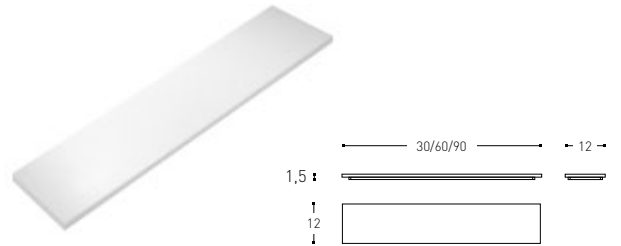

ESTANTE
 FLAT SHELF
 TABLETTE
 MENSOLA
 PRATELEIRA
 ABLAGE
 REK

INCH 11.8/23.6/35.4x4.7x0.8

- MX** 229 05 45 30 CM / INCH 11.8 \$ 1,650.00
- 229 05 46 60 CM / INCH 23.6 \$ 2,240.00
- 229 05 47 90 CM / INCH 35.4 \$ 2,880.00



PORTAPAPEL CON TAPA
 PAPER HOLDER WITH COVER
 PORTE - ROULEAUX COUVERT
 PORTAROTOLO CON COPERCHIO
 PORTA - ROLO COM TAPA
 ROLLENHALTER MIT DECKEL
 TOILETROLHOUDER MET KLEP

INCH 6.3x4.7x2.4

- MX** 229 01 56 \$ 2,830.00



PORTAPAPEL CON TAPA
 PAPER HOLDER WITH COVER
 PORTE - ROULEAUX COUVERT
 PORTAROTOLO CON COPERCHIO
 PORTA - ROLO COM TAPA
 ROLLENHALTER MIT DECKEL
 TOILETROLHOUDER MET KLEP

INCH 6.3x4.7x2.4

- MX** 229 01 59 \$ 2,830.00



PORTAPAPEL
 PAPER HOLDER
 PORTE - ROULEAUX
 PORTAROTOLO
 PORTA - ROLO
 ROLLENHALTER
 TOILETROLHOUDER

INCH 6.3x4.7x0.8

- MX** 229 01 62 \$ 2,010.00



PORTAPAPEL
 PAPER HOLDER
 PORTE - ROULEAUX
 PORTAROTOLO
 PORTA - ROLO
 ROLLENHALTER
 TOILETROLHOUDER

INCH 6.3x3.3x0.8

- MX** 229 01 58 \$ 2,010.00

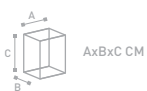

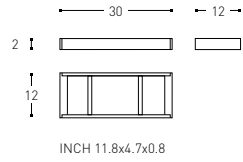

- PORTAPEL DOBLE
- DOUBLE PAPER HOLDER
- PORTE - ROULEAUX DOUBLE
- PORTAROTOLO DOPPIO
- PORTA - ROLO DUPLO
- DOPPELTER ROLLENHALTER
- DUBBELE TOILETROLHOUDER

● 229 01 57
\$ 2,830.00

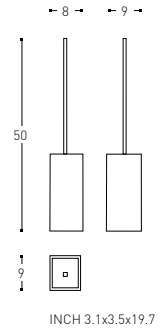

- △ ESCOBILLERO SUELO / PARED
- △ TOILET BRUSH FLOOR / WALL
- △ PORTE - BALAYETTE SOL / MUR
- △ PORTASCOPINO SUOLO / MURO
- △ PORTA - PIACABA SOLO / PAREDE
- △ TOILETTENBUERSTENHALTER BODEN / WAND
- △ WC - BORSTELHOUDER VLOER / MUUR

● 229 01 00
\$ 2,490.00



bath life

recambios spare parts pièces détachées ricambi peças de reposição ersatzteile reserveonderdelen

ACCESORIO SUJECIÓN PARED (1 TORNILLO) / WALL MOUNTING SET (1 SCREW) / KIT FIXATION MURALE (1 VIS) / ACCESSORIO FISSAGGIO MURO (1 VITE) / CONJUNTO FIXAÇÃO PAREDE (1 PARAFUSO) / WANDFIXIERUNGSSET (1 SCHRAUBE) / MONTAGESET WAND (1 SCHROEF)

330 86 00 \$ 140.00

RECAMBIO DE / SPARE PART OF / PIÈCE DÉTACHÉE DE / RICAMBIO DI / PEÇA DE REPOSIÇÃO DE / ERSATZTEIL FÜR / ONDERDEEL VAN
2290140, 2290157, 2290158, 2290160, 2290163, 2290164, 2290165, 2290169, 2290170

ACCESORIO SUJECIÓN / MOUNTING SET / KIT FIXATION / ACCESSORIO FISSAGGIO / CONJUNTO FIXAÇÃO / FIXIERUNGSSET / MONTAGESET

341 00 46 \$ 120.00

RECAMBIO DE / SPARE PART OF / PIÈCE DÉTACHÉE DE / RICAMBIO DI / PEÇA DE REPOSIÇÃO DE / ERSATZTEIL FÜR / ONDERDEEL VAN
2290121

ACCESORIO SUJECIÓN / MOUNTING SET / KIT FIXATION / ACCESSORIO FISSAGGIO / CONJUNTO FIXAÇÃO / FIXIERUNGSSET / MONTAGESET

341 06 75 \$ 120.00

RECAMBIO DE / SPARE PART OF / PIÈCE DÉTACHÉE DE / RICAMBIO DI / PEÇA DE REPOSIÇÃO DE / ERSATZTEIL FÜR / ONDERDEEL VAN
2290156

341 06 76 \$ 120.00

RECAMBIO DE / SPARE PART OF / PIÈCE DÉTACHÉE DE / RICAMBIO DI / PEÇA DE REPOSIÇÃO DE / ERSATZTEIL FÜR / ONDERDEEL VAN
2290162

ACCESORIO SUJECIÓN BÁSICO / BASIC MOUNTING SET / KIT FIXATION DE BASE / ACCESSORIO FISSAGGIO BASE / CONJUNTO FIXAÇÃO BASICO / STANDARD FIXIERUNGSSET / MONTAGESET FUNDAMENTEEL

341 00 18 \$ 120.00

RECAMBIO DE / SPARE PART OF / PIÈCE DÉTACHÉE DE / RICAMBIO DI / PEÇA DE REPOSIÇÃO DE / ERSATZTEIL FÜR / ONDERDEEL VAN
2290100, 2290159

ACCESORIO SUJECIÓN TRIPLE / TRIPLE MOUNTING SET / KIT TRIPLE FIXATION / ACCESSORIO TRIPLO FISSAGGIO / CONJUNTO FIXAÇÃO TRIPLO / DREIFACHFIXIERUNGSSET / TRIPLE MONTAGESET

341 01 22 \$ 230.00

RECAMBIO DE / SPARE PART OF / PIÈCE DÉTACHÉE DE / RICAMBIO DI / PEÇA DE REPOSIÇÃO DE / ERSATZTEIL FÜR / ONDERDEEL VAN
2290168, 2290174

ACCESORIO SUJECIÓN PLÁSTICO TRIPLE / TRIPLE PLASTIC MOUNTING SET / KIT TRIPLE FIXATION PLASTIQUE / ACCESSORIO TRIPLO FISSAGGIO IN PLASTICA / CONJUNTO FIXAÇÃO PLÁSTICO TRIPLO / KUNSTSTOFF DREIFACHFIXIERUNGSSET / TRIPLE PLASTIC MONTAGESET

341 01 25 \$ 120.00

RECAMBIO DE / SPARE PART OF / PIÈCE DÉTACHÉE DE / RICAMBIO DI / PEÇA DE REPOSIÇÃO DE / ERSATZTEIL FÜR / ONDERDEEL VAN
2290171

ACCESORIO SUJECIÓN ESTANTE / SHELF MOUNTING SET / KIT FIXATION TABLETTE / ACCESSORIO DI FISSAGGIO MENSOLA / CONJUNTO FIXAÇÃO PRATELEIRA / ABLAGEFIXIERUNGSSET / MONTAGESET REK

341 03 03 \$ 140.00

RECAMBIO DE / SPARE PART OF / PIÈCE DÉTACHÉE DE / RICAMBIO DI / PEÇA DE REPOSIÇÃO DE / ERSATZTEIL FÜR / ONDERDEEL VAN
2290140, 2290160, 2290170

ACCESORIO SUJECION ESCOBILLERO / TOILET BRUSH FIXATION SET / ACCESSOIRE FIXATION PORTE-BALAYETTE / SET FISSAGGIO MURO PORTASCOPINO / PEÇA DE FIXAÇÃO DE PIAÇABA / FIXIERUNGSSET FÜR TOILETTENBÜRSTENHALTER / TOILET BORSTEL BEVESTIGING SET

341 03 07 \$ 120.00

RECAMBIO DE / SPARE PART OF / PIÈCE DÉTACHÉE DE / RICAMBIO DI / PEÇA DE REPOSIÇÃO DE / ERSATZTEIL FÜR / ONDERDEEL VAN
2290100

JUEGO BIS SUJECIÓN (M5/M6) / SCREW MOUNTING SET (M5/M6) / SET VIS FIXATION (M5/M6) / KIT VITE FISSAGGIO (M5/M6) / CONJUNTO BIS FIXAÇÃO (M5/M6) / MADENSCHRAUBENSSET (M5/M6) / MONTAGESET (M5/M6)

330 91 00 \$ 60.00

PULSADOR + BOMBA DOSIFICADOR / DISPENSER PUSH BUTTON + PUMP / POUSSOIR + POMPE PORTE-SAVON LIQUIDE / PULSANTE + POMPETTA DISPENSER / BOTÃO + BOMBA DOSEADOR / PUMPENKOPF FÜR SEIFENSPENDER / DRUKKNOP + POMP VERDELER VLOEIBARE ZEEP

341 06 16 \$ 540.00
341 06 50 \$ 1,330.00

RECAMBIO DE / SPARE PART OF / PIÈCE DÉTACHÉE DE / RICAMBIO DI / PEÇA DE REPOSIÇÃO DE / ERSATZTEIL FÜR / ONDERDEEL VAN
2290104, 2290105

BOMBA DOSIFICADOR / DISPENSER PUMP / POMPE PORTE-SAVON LIQUIDE / POMPETTA DISPENSER / BOMBA DISPENSADOR / DOSIERPUMPE SEIFENSPENDER / DOSEERPOMPJE

341 06 22 \$ 140.00

RECAMBIO DE / SPARE PART OF / PIÈCE DÉTACHÉE DE / RICAMBIO DI / PEÇA DE REPOSIÇÃO DE / ERSATZTEIL FÜR / ONDERDEEL VAN
2290104, 2290105

EJE PORTAPAPEL DOBLE / CROSS AXIS DOUBLE PAPER HOLDER / AXE PORTE-ROULEAUX DOUBLE / ASSE PORTAROTOLO DOPPIO / EJE PORTA ROLO DUPLO / QUERACHSE DOPPELTER ROLLENHALTER / HAAKSE DUBBELE TOILETROLHOUDER

341 03 23 \$ 390.00

RECAMBIO DE / SPARE PART OF / PIÈCE DÉTACHÉE DE / RICAMBIO DI / PEÇA DE REPOSIÇÃO DE / ERSATZTEIL FÜR / ONDERDEEL VAN
2290157

EJE PORTAPAPEL / CROSS AXIS PAPER HOLDER / AXE PORTE-ROULEAUX / ASSE PORTAROTOLO / EJE PORTA ROLO / QUERACHSE ROLLENHALTER / HAAKSE TOILETROLHOUDER

341 03 24 \$ 390.00

RECAMBIO DE / SPARE PART OF / PIÈCE DÉTACHÉE DE / RICAMBIO DI / PEÇA DE REPOSIÇÃO DE / ERSATZTEIL FÜR / ONDERDEEL VAN
2290158, 2290159

VASO ESCOBILLERO / TOILET BRUSH GLASS / VERRE PORTE-BALAYETTE / BICCHIERE PORTASCOPINO / COPO PORTA-PIAÇABA / GLAS TOILETTENBÜRSTENHALTER / WC-BORSTELHOUDERPOT

341 00 30 \$ 860.00

RECAMBIO DE / SPARE PART OF / PIÈCE DÉTACHÉE DE / RICAMBIO DI / PEÇA DE REPOSIÇÃO DE / ERSATZTEIL FÜR / ONDERDEEL VAN
2290100

PALO ESCOBILLERO CON CEPILLO / TOILET BRUSH STICK WITH BRUSH / MANCHE BALAYETTE AVEC BROSSE / MANICO SCOPINO CON SPAZZOLINO / ESCOVA COM CABO PORTA-PIAÇABA / TOILETTENBÜRSTE MIT GRIFF / HANDVAT MET BORSTEL

341 00 41 \$ 1,560.00

RECAMBIO DE / SPARE PART OF / PIÈCE DÉTACHÉE DE / RICAMBIO DI / PEÇA DE REPOSIÇÃO DE / ERSATZTEIL FÜR / ONDERDEEL VAN
2290100

CEPILLO ESCOBILLERO / TOILET BRUSH BRUSH / BROSSE PORTE-BALAYETTE / SPAZZOLINO PORTASCOPINO / ESCOVA PARA PIAÇABA / TOILETTENBÜRSTENKOPF / BORSTEL WC-BORSTELHOUDER

350 11 00 Blanco / White / Blanc / Bianco / Branco / Weiss / Wit \$ 280.00
341 03 13 Negro / Black / Noir / Nero / Preto / Schwarz / Zwart \$ 280.00

RECAMBIO DE / SPARE PART OF / PIÈCE DÉTACHÉE DE / RICAMBIO DI / PEÇA DE REPOSIÇÃO DE / ERSATZTEIL FÜR / ONDERDEEL VAN
2290100

**TACO PLADUR / DRYWALL ANCHOR / CHEVILLE PLACOPLÂTRE / TASSELLO
CARTONGESSO / TACO PLADUR / DÜBEL FÜR RIGIPS-PLATTEN / GIPSPLAAT PLUG**

341 06 35 **\$ 130.00**

RECAMBIO DE / SPARE PART OF / PIÈCE DÉTACHÉE DE / RICAMBIO DI /
PEÇA DE REPOSIÇÃO DE / ERSATZTEIL FÜR / ONDERDEEL VAN
2290156, 2290162

341 06 36 **\$ 150.00**

RECAMBIO DE / SPARE PART OF / PIÈCE DÉTACHÉE DE / RICAMBIO DI /
PEÇA DE REPOSIÇÃO DE / ERSATZTEIL FÜR / ONDERDEEL VAN
2290100, 2290105, 2290121, 2290140, 2290152, 2290157, 2290158, 2290159,
2290160, 2290163, 2290164, 2290165, 2290168, 2290169, 2290170, 2290171,
2290174





El **contraste** cromático más clásico permite transformar el baño en un ambiente **atrevido** o bien **fundirse** con el resto de elementos para convertir los entornos en **armónicos** y **diáfanos**.

*The classic colour **contrast** transforms the bathroom into a **bold** atmosphere or blends it in to the other components to create **harmonious** and **diaphanous** environments.*

black & white

DESIGN BY COSMIC STUDIO

black&white



Características

Fácil instalación: tornillo de doble paso. Fijaciones ocultas. Anticorrosión. Pintura libre de plomo.

Features

Easy installation: double pitch screw. Hidden attachments. Anti-corrosion. Lead free paint.

Caractéristiques :

Facile installation : vis à double pas. Fixations occultes. Anti-corrosion. Peinture sans plomb.

Caratteristiche:

Facile installazione : vite a doppio passo. Fissaggio nascosto. Anticorrosivo. Vernice senza piombo.

Características:

Fácil instalação: parafuso de dupla passagem. Fixações ocultas. Anti-corrosão. Pintura sem chumbo.

Eigenschaften:

Einfache montage: doppel-pass-schraube. Unsichtbare Befestigungen. Korrosionsschutz. Farbe bleifrei.

Kenmerken:

Eenvoudig te monteren: schroef met dubbele draad. Verborgen bevestigingen. Corrosiewerend. Loodvrije verf.



Acabados Finishes Finitions Finiture Acabamentos Oberflächen Afwerkingen



05/15

Blanco
White
Blanc
Bianco
Branco
Weiss
Wit



06

Negro
Black
Noir
Nero
Preto
Schwarz
Zwart

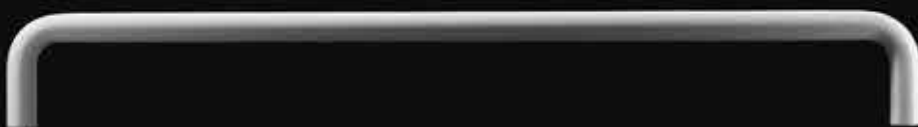

black&white

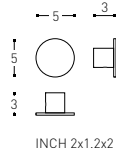

- COLGADOR
- HOOK
- PATÈRE
- APPENDINO
- CABIDE
- HAKEN
- KLEDINGHAAK

238 15 21 BLANCO / WHITE
\$ 880.00

238 06 21 NEGRO / BLACK
\$ 880.00

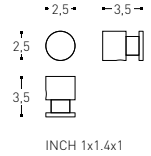

- PORTAGUANTES
- GLOVE HOOK
- PORTE-GANTS
- PORTAGUANTI
- PORTA-LUVAS
- HAKEN
- KLEDINGHAAK

238 15 20 BLANCO / WHITE
\$ 570.00

238 06 20 NEGRO / BLACK
\$ 570.00

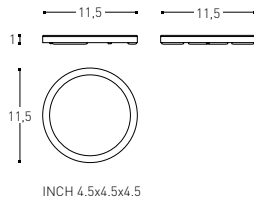

- △ JABONERA ENCIMERA
- FREE STANDING SOAP DISH
- PORTE-SAVON À POSER
- PORTASAPONE D'APPOGGIO
- SABONETEIRA DE BANCADA
- SEIFENSCHALE FÜR ABLAGE
- ZEEPBAKJE VOOR BLAD

251 05 34 BLANCO / WHITE
\$ 1,300.00

251 06 34 NEGRO / BLACK
\$ 1,300.00

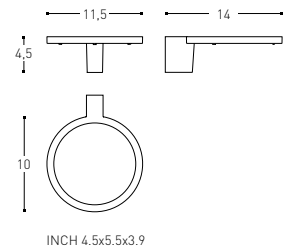

- △ JABONERA
- SOAP DISH
- PORTE-SAVON
- PORTASAPONE
- SABONETEIRA
- SEIFENSCHALE
- ZEEPBAKJE

251 05 32 BLANCO / WHITE
\$ 1,660.00

251 06 32 NEGRO / BLACK
\$ 1,660.00

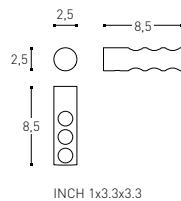

- PORTACEPILLOS
- BRUSH-HOLDER
- PORTE-BROSSE À DENTS
- PORTASPAZZOLINI
- PORTA-ESCOVA
- ZAHNBÜRSTENHALTER
- TANDENBORSTELHOUDER

238 05 35 BLANCO / WHITE
\$ 930.00

238 06 35 NEGRO / BLACK
\$ 930.00

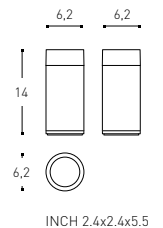

- PORTACEPILLOS ENCIMERA
- FREE STANDING BRUSH-HOLDER
- PORTE-BROSSE À DENTS À POSER
- PORTASPAZZOLINI DA APPOGGIO
- PORTA-ESCOVA DE DENTES DE BANCADA
- ZAHNBÜRSTENHALTER FÜR AUFLAGE
- TANDENBORSTELHOUDER VOOR BLAD

251 05 53 BLANCO / WHITE
\$ 1,460.00

251 06 53 NEGRO / BLACK
\$ 1,460.00



AxBxC CM

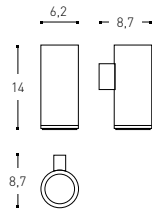

INCH 2.4x3.4x5.5

- PORTACEPILLOS
BRUSH-HOLDER
PORTE-BROSSE À DENTS
PORTASPAZZOLINI
PORTA-ESCOVA DE DENTES
ZAHBÜRSTENHALTER
TANDENBORSTELHOUDER

251 05 54 BLANCO / WHITE
\$ 1,820.00

251 06 54 NEGRO / BLACK
\$ 1,820.00

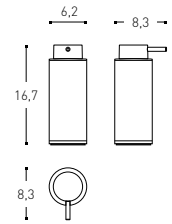

INCH 2.4x3.3x6.6

- DOSIFICADOR ENCIMERA
FREE STANDING SOAP DISPENSER
PORTE-SAVON LIQUIDE À POSER
DISPENSER DA APPOGGIO
DISPENSADOR SABONETE DE BANCADA
AUFLAGESEIFENSPENDER
DOSEERDER VOOR BLAD

251 05 04 BLANCO / WHITE
\$ 1,680.00

251 06 04 NEGRO / BLACK
\$ 1,680.00

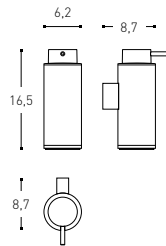

INCH 2.4x3.4x6.6

- DOSIFICADOR
SOAP DISPENSER
PORTE-SAVON LIQUIDE
DISPENSER
DISPENSADOR SABONETE
SEIFENSPENDER
DOSEERDER

251 05 05 BLANCO / WHITE
\$ 2,050.00

251 06 05 NEGRO / BLACK
\$ 2,050.00

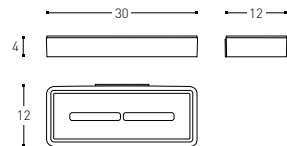

INCH 11.8x4.7x1.6

- △ CONTAINER
BASKET
PANIER
CESTINO
CONTÊNER
WANDKORB
REKJE

251 05 49 BLANCO / WHITE
\$ 2,240.00

251 06 49 NEGRO / BLACK
\$ 2,240.00

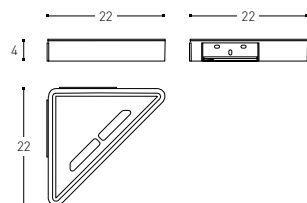

INCH 8.7x8.7x1.6

- △ CONTAINER RINCÓN
CORNER BASKET
PANIER ANGLE
CESTINO ANGOLO
CONTÊNER DE CANTO
ECKWANDKORB
REKJE HOEKVORM

251 05 50 BLANCO / WHITE
\$ 2,030.00

251 06 50 NEGRO / BLACK
\$ 2,030.00

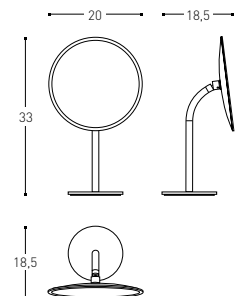

INCH 7.9x7.3x13

- △ ◆ ESPEJO AUMENTO ENCIMERA (X3)
FREE STANDING MAGNIFYING MIRROR (X3)
MIRROIR GROSSISSANT À POSER D.20CM (X3)
SPECCHIO AUMENTO DA APPOGGIO (X3)
ESPELHO AUMENTO BANCADA (X3)
AUFLAGEVERGRÖSSERUNGSSPIEGEL (X3)
VERGROOTSPIEGEL VOOR BLAD (X3)

251 05 83 BLANCO / WHITE
\$ 3,080.00

251 06 83 NEGRO / BLACK
\$ 3,080.00

black&white

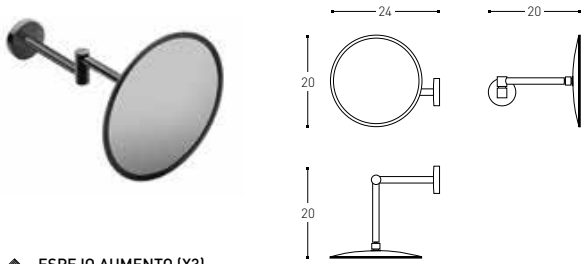

- ④ △ ◆ ESPEJO AUMENTO (X3)
- MAGNIFYING MIRROR (X3)
- MIROIR GROSSISSANT D.20CM (x3)
- SPECCHIO AUMENTO (X3)
- ESPELHO AUMENTO (X3)
- VERGRÖßERUNGSSPIEGEL (X3)
- VERGROOTSPIEGEL (X3)

251 05 85 BLANCO / WHITE
\$ 2,740.00

251 06 85 NEGRO / BLACK
\$ 2,740.00

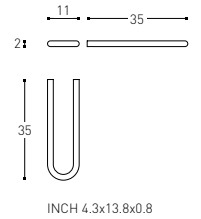

INCH 4.3x13.8x0.8

- ④ TOALLERO DOBLE
- DOUBLE TOWEL BAR
- PORTE-SERVLETTE DOUBLE
- PORTASALVIETTE DOPPIO
- TOALHEIRO DUPLO
- DOPPELTE HUNDTUCHSTANGE
- DUBBELE HANDDOEKHOUDER

238 05 61 BLANCO / WHITE
\$ 2,100.00

238 06 61 NEGRO / BLACK
\$ 2,100.00

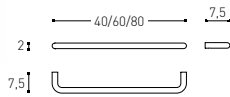

INCH 15.7/23.6/31.5x2.9x0.8

- ④ TOALLERO
- TOWEL RACK
- PORTE - SERVIETTE
- PORTASALVIETTE
- TOALHEIRO
- HANDTUCHSTANGE
- HANDDOEKHOUDER

238 15 64 BLANCO / WHITE - 40 CM / INCH 15.7 **\$ 1,640.00**

238 06 64 NEGRO / BLACK - 40 CM / INCH 15.7 **\$ 1,640.00**

238 15 65 BLANCO / WHITE - 60 CM / INCH 23.6 **\$ 1,840.00**

238 06 65 NEGRO / BLACK - 60 CM / INCH 23.6 **\$ 1,840.00**

238 15 66 BLANCO / WHITE - 80 CM / INCH 31.5 **\$ 2,080.00**

238 06 66 NEGRO / BLACK - 80 CM / INCH 31.5 **\$ 2,080.00**

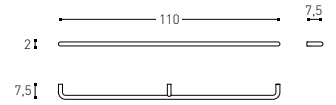
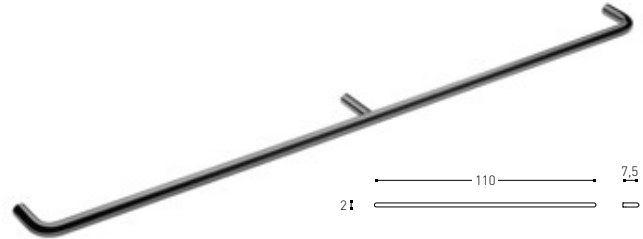

INCH 43.3x2.9x0.8

- ④ TOALLERO
- TOWEL RACK
- PORTE - SERVIETTE
- PORTASALVIETTE
- TOALHEIRO
- HANDTUCHSTANGE
- HANDDOEKHOUDER

238 15 67 BLANCO / WHITE - 110 CM / INCH 43.3 **\$ 3,680.00**

238 06 67 NEGRO / BLACK - 110 CM / INCH 43.3 **\$ 3,680.00**

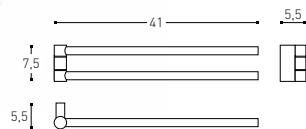

INCH 16.1x2.2x2.9

- ④ TOALLERO GIRATORIO DOBLE
- SWIVEL DOUBLE TOWEL BAR
- PORTE-SERVLETTE PIVOTANT DOUBLE
- PORTASALVIETTE A SNODO DOPPIO
- TOALHEIRO GIRATORIO DUPLO
- DOPPELTE HANDTUCHSTANGE SCHWENKBAR
- DUBBELE HANDDOEKHOUDER DRAAIBAAR

251 05 75 BLANCO / WHITE
\$ 3,080.00

251 06 75 NEGRO / BLACK
\$ 3,080.00

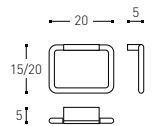

INCH 7.9x2x5.9/7.9

- ④ TOALLERO ARO
- TOWEL RING
- PORTE - SERVIETTE ANNEAU
- PORTASALVIETTE ANELLO
- TOALHEIRO ARGOLA
- HANDTUCHRING
- HANDDOEKHRING

251 05 71 BLANCO / WHITE - 15 CM / INCH 5.9 **\$ 1,820.00**

251 06 71 NEGRO / BLACK - 15 CM / INCH 5.9 **\$ 1,820.00**

251 05 72 BLANCO / WHITE - 20 CM / INCH 7.9 **\$ 2,010.00**

251 06 72 NEGRO / BLACK - 20 CM / INCH 7.9 **\$ 2,010.00**



AxBxC CM

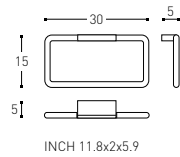

INCH 11.8x2x5.9

- TOALLERO ARO
TOWEL RING
PORTE - SERVIETTE ANNEAU
PORTASALVIETTE ANELLO
TOALHEIRO ARGOLA
HANDTUCHRING
HANDDOEKRING

251 05 82 BLANCO / WHITE
\$ 2,170.00

251 06 82 NEGRO / BLACK
\$ 2,170.00

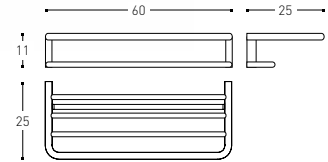
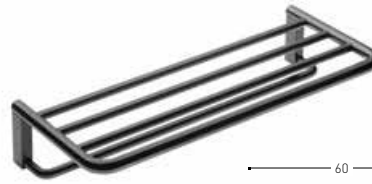

INCH 23.6x9.8x4.3

- TOALLERO ESTANTE
TOWEL RACK SHELF
PORTE-SERVIETTE TABLETTE
PORTASALVIETTE MENSOLA
TOALHEIRO PRATELEIRA
HANDTUCHSTANGE/ABLAGE
HANDDOEKHOUDER REK

251 05 68 BLANCO / WHITE
\$ 6,400.00

251 06 68 NEGRO / BLACK
\$ 6,400.00

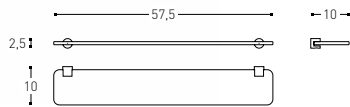
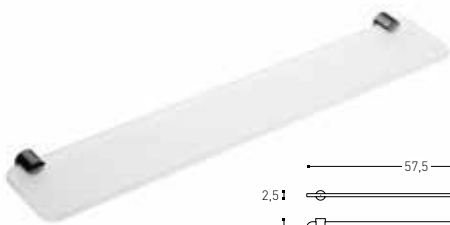

INCH 22.6x3.9x3.9

- ESTANTE VIDRIO
GLASS SHELF
TABLETTE VITRÉE
MENSOLA VETRO
PRATELEIRA VIDRO
GLASABLAGE
GLAZEN REK

238 05 45 BLANCO / WHITE
\$ 1,930.00

238 06 45 NEGRO / BLACK
\$ 1,930.00

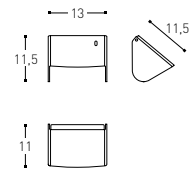

INCH 5.1x4.5x4.5

- PORTAPAPEL CON TAPA
PAPER HOLDER WITH COVER
PORTE-ROULEAUX AVEC COUVERCLE
PORTAROTOLO CON COPERCHIO
PORTA-ROLO COM TAMPA
ROLLENHALTER MIT DECKEL
TOILETROLHOUDER MET KLEP

238 05 59 BLANCO / WHITE
\$ 1,610.00

238 06 59 NEGRO / BLACK
\$ 1,610.00

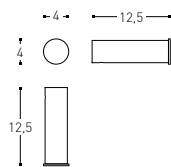

INCH 1.6x4.9x1.6

- PORTAPAPEL SIN TAPA
PAPER HOLDER WITHOUT COVER
PORTE-ROULEAUX SANS COUVERCLE
PORTAROTOLO SENZA COPERCHIO
PORTA-ROLO SEM TAMPA
ROLLENHALTER OHNE DECKEL
TOILETROLHOUDER ZONDER KLEP

238 15 58 BLANCO / WHITE
\$ 1,160.00

238 06 58 NEGRO / BLACK
\$ 1,160.00

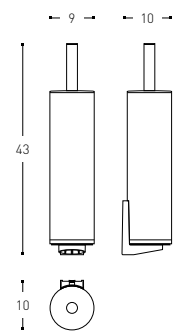

INCH 3.5x3.9x16.9

- ESCOBILLERO SUELO/PARED
FREE-STANDING OR WALL MOUNTABLE TOILET BRUSH
PORTE-BALAYETTE SOL/MUR
PORTASCOPINO A TERRA/MURO
PORTA-PIACABA SOLO/PAREDE
TOILETTENBÜRSTENHALTER BODEN/WAND
WC-BORSTELHOUDER VLOER/MUUR

251 05 00 BLANCO / WHITE
\$ 2,790.00

251 06 00 NEGRO / BLACK
\$ 2,790.00

black&white

recambios spare parts pièces détachées ricambi peças de reposição ersatzteile reserveonderdelen

ACCESORIO SUJECIÓN BÁSICO / BASIC MOUNTING SET / KIT FIXATION DE BASE / ACCESSORIO FISSAGGIO BASE / CONJUNTO FIXAÇÃO BÁSICO / STANDARD FIXIERUNGSSET / MONTAGESET FUNDAMENTEEL

341 00 18 \$ 120.00

RECAMBIO DE / SPARE PART OF / PIÈCE DÉTACHÉE DE / RICAMBIO DI / PEÇA DE REPOSIÇÃO DE / ERSATZTEIL FÜR / ONDERDEEL VAN 2380545, 2380559, 2380645, 2380659

ACCESORIO SUJECIÓN PARED REDONDO / ROUND WALL MOUNTING SET / KIT FIXATION MURALE ROND / ACCESSORIO FISSAGGIO MURO ROTONDO / CONJUNTO FIXAÇÃO PAREDE REDONDA / WANDFIXIERUNGSSET RUND / MONTAGESET WAND ROND

330 76 00 \$ 140.00

RECAMBIO DE / SPARE PART OF / PIÈCE DÉTACHÉE DE / RICAMBIO DI / PEÇA DE REPOSIÇÃO DE / ERSATZTEIL FÜR / ONDERDEEL VAN 2510568, 2510668

ACCESORIO SUJECIÓN PARED / WALL MOUNTING SET / KIT FIXATION MURALE / ACCESSORIO FISSAGGIO MURO / CONJUNTO FIXAÇÃO PAREDE / WANDFIXIERUNGSSET / MONTAGESET WAND

341 01 21 \$ 120.00

RECAMBIO DE / SPARE PART OF / PIÈCE DÉTACHÉE DE / RICAMBIO DI / PEÇA DE REPOSIÇÃO DE / ERSATZTEIL FÜR / ONDERDEEL VAN 2510532, 2510632

ACCESORIO SUJECIÓN TRIPLE / TRIPLE MOUNTING SET / KIT TRIPLE FIXATION / ACCESSORIO TRIPLO FISSAGGIO / CONJUNTO FIXAÇÃO TRIPLO / DREIFACHFIXIERUNGSSET / TRIPLE MONTAGESET

341 01 22 \$ 230.00

RECAMBIO DE / SPARE PART OF / PIÈCE DÉTACHÉE DE / RICAMBIO DI / PEÇA DE REPOSIÇÃO DE / ERSATZTEIL FÜR / ONDERDEEL VAN 2510568, 2510585, 2510668, 2510685

ACCESORIO SUJECIÓN PLÁSTICO TRIPLE / TRIPLE PLASTIC MOUNTING SET / KIT TRIPLE FIXATION PLASTIQUE / ACCESSORIO TRIPLO FISSAGGIO IN PLASTICA / CONJUNTO FIXAÇÃO PLÁSTICO TRIPLO / KUNSTSTOFF DREIFACHFIXIERUNGSSET / TRIPLE PLASTIC MONTAGESET

341 01 25 \$ 120.00

RECAMBIO DE / SPARE PART OF / PIÈCE DÉTACHÉE DE / RICAMBIO DI / PEÇA DE REPOSIÇÃO DE / ERSATZTEIL FÜR / ONDERDEEL VAN 2510571, 2510572, 2510582, 2510671, 2510672, 2510682

ACCESORIO SUJECIÓN / MOUNTING SET / KIT FIXATION / ACCESSORIO FISSAGGIO / FIXAÇÃO PAREDE / FIXIERUNGSSET / MONTAGESET

340 65 00 \$ 520.00

RECAMBIO DE / SPARE PART OF / PIÈCE DÉTACHÉE DE / RICAMBIO DI / PEÇA DE REPOSIÇÃO DE / ERSATZTEIL FÜR / ONDERDEEL VAN 2380535, 2380561, 2380620, 2380621, 2380635, 2380658, 2380661, 2380664, 380665, 2380666, 2380667, 2381520, 2381521, 2381558, 2381564, 2381565, 2381566, 2381567

PULSADOR+BOMBA DOSIFICADOR / DISPENSER PUSH BUTTON + PUMP / POUSSOIR + POMPE PORTE-SAVON LIQUIDE / PULSANTE + POMPETTA DISPENSER / BOTÃO + BOMBA DOSEADOR / PUMPENKOPF FÜR SEIFENSPENDER / DRUKKNOP + POMP VERDELER VLOEIBARE ZEEP

340 90 21 Blanco / White / Blanc / Bianco / Branco / Weiss / Wit \$ 690.00

RECAMBIO DE / SPARE PART OF / PIÈCE DÉTACHÉE DE / RICAMBIO DI / PEÇA DE REPOSIÇÃO DE / ERSATZTEIL FÜR / ONDERDEEL VAN 2510504, 2510505

340 90 22 Negro / Black / Noir / Nero / Preto / Schwarz / Zwart \$ 690.00

RECAMBIO DE / SPARE PART OF / PIÈCE DÉTACHÉE DE / RICAMBIO DI / PEÇA DE REPOSIÇÃO DE / ERSATZTEIL FÜR / ONDERDEEL VAN 2510604, 2510605

BOMBA DOSIFICADOR / DISPENSER PUMP / POMPE PORTE-SAVON LIQUIDE / POMPETTA DISPENSER / BOMBA DISPENSADOR / DOSIERPUMPE SEIFENSPENDER / DOSEERPOMPJE

341 06 22 \$ 140.00

RECAMBIO DE / SPARE PART OF / PIÈCE DÉTACHÉE DE / RICAMBIO DI / PEÇA DE REPOSIÇÃO DE / ERSATZTEIL FÜR / ONDERDEEL VAN 2510504, 2510505, 2510604, 2510605

LUNA ESPEJO / GLASS MIRROR / GLACE / VETRO SPECCHIO / LUNA ESPELHO / GLASSPIEGEL / GLAS SPIEGEL

341 04 73 Blanco / White / Blanc / Bianco / Branco / Weiss / Wit \$ 590.00

RECAMBIO DE / SPARE PART OF / PIÈCE DÉTACHÉE DE / RICAMBIO DI / PEÇA DE REPOSIÇÃO DE / ERSATZTEIL FÜR / ONDERDEEL VAN 2510583, 2510585

341 04 72 Negro / Black / Noir / Nero / Preto / Schwarz / Zwart \$ 590.00

RECAMBIO DE / SPARE PART OF / PIÈCE DÉTACHÉE DE / RICAMBIO DI / PEÇA DE REPOSIÇÃO DE / ERSATZTEIL FÜR / ONDERDEEL VAN 2510683, 2510685

ESTANTE / SHELF / TABLETTE / MENSOLA / PRATELEIRA / ABLAGE / REK

340 66 00 57,5 CM / INCH 22.6 \$ 1,530.00

RECAMBIO DE / SPARE PART OF / PIÈCE DÉTACHÉE DE / RICAMBIO DI / PEÇA DE REPOSIÇÃO DE / ERSATZTEIL FÜR / ONDERDEEL VAN 2380545, 2380645

PALO ESCOBILLERO CON CEPILLO / TOILET BRUSH STICK WITH BRUSH / MANCHE BALAYETTE AVEC BROSSE / MANICO SCOPINO CON SPAZZOLINO / ESCOVA COM CABO PORTA-PIAÇABA / TOILETTENBÜRSTE MIT GRIFF / HANDVAT MET BORSTEL

340 90 19 Blanco / White / Blanc / Bianco / Branco / Weiss / Wit \$ 880.00

RECAMBIO DE / SPARE PART OF / PIÈCE DÉTACHÉE DE / RICAMBIO DI / PEÇA DE REPOSIÇÃO DE / ERSATZTEIL FÜR / ONDERDEEL VAN 2510500

340 90 18 Negro / Black / Noir / Nero / Preto / Schwarz / Zwart \$ 890.00

RECAMBIO DE / SPARE PART OF / PIÈCE DÉTACHÉE DE / RICAMBIO DI / PEÇA DE REPOSIÇÃO DE / ERSATZTEIL FÜR / ONDERDEEL VAN 2510600

CEPILLO ESCOBILLERO / TOILET BRUSH BRUSH / BROSSE PORTE-BALAYETTE / SPAZZOLINO PORTASCOPINO / ESCOVA PARA PIAÇABA / TOILETTENBÜRSTENKOPF / BORSTEL WC-BORSTELHOUDER

350 11 00 Blanco / White / Blanc / Bianco / Branco / Weiss / Wit \$ 280.00

341 03 13 Negro / Black / Noir / Nero / Preto / Schwarz / Zwart \$ 280.00

RECAMBIO DE / SPARE PART OF / PIÈCE DÉTACHÉE DE / RICAMBIO DI / PEÇA DE REPOSIÇÃO DE / ERSATZTEIL FÜR / ONDERDEEL VAN 2510500, 2510600

TACO PLADUR / DRYWALL ANCHOR / CHEVILLE PLACOPLÂTRE / TASSELLO CARTONGESSO / TACO PLADUR / DÜBEL FÜR RIGIPS-PLATTEN / GIPSPLAAT PLUG

341 06 36 \$ 150.00

RECAMBIO DE / SPARE PART OF / PIÈCE DÉTACHÉE DE / RICAMBIO DI / PEÇA DE REPOSIÇÃO DE / ERSATZTEIL FÜR / ONDERDEEL VAN 2510500, 2510505, 2510532, 2510549, 2510550, 2510554, 2510568, 2510571, 2510572, 2510575, 2510582, 2510585, 2510600, 2510605, 2510632, 2510649, 2510650, 2510654, 2510668, 2510671, 2510672, 2510675, 2510682, 2510685





Formas **funcionales**
que no renuncian a ese
toque de **elegancia**
que las convierte en
singulares.

*Functional forms that
do not renounce the touch
of elegance that makes
them unique.*

**con
tract**

DESIGN BY COSMIC STUDIO



contract

10

AÑOS
GARANTÍA
YEARS
GUARANTEE
COSMIC

Características

Fácil instalación: tornillo de doble paso.
Fijaciones ocultas. Anticorrosión.

Features

*Easy installation: double pitch screw.
Hidden attachments. Anti-corrosion.*

Caractéristiques :

Facile installation : vis à double pas.
Fixations occultes. Anti-corrosion.

Caratteristiche:

*Facile installazione : vite a doppio passo.
Fissaggio nascosto. Anticorrosivo.*

Características:

Fácil instalação: parafuso de dupla
passagem. Fixações ocultas.
Anti-corrosão.

Eigenschaften:

*Einfache montage: doppel-pass-
schraube. Unsichtbare Befestigungen.
Korrosionsschutz.*

Kenmerken:

Eenvoudig te monteren: schroef met
dubbele draad. Verborgene bevestigingen.
Corrosiewerend.



Acabados
Finishes
Finitions
Finiture
Acabamentos
Oberflächen
Afwerkingen



Cromo
Chrome
Chromé
Cromo
Cromo
Chrom
Verchromd

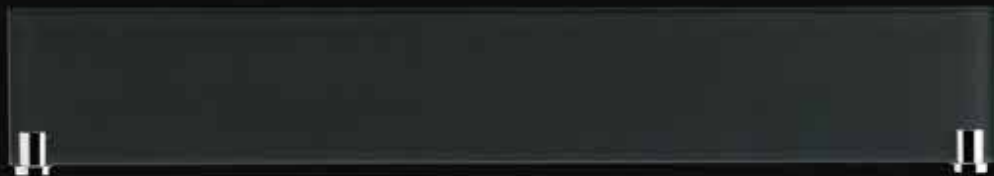

contract

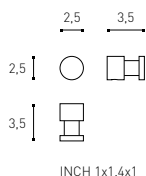

INCH 1x1.4x1

- COLGADOR
HANGER
PATÈRE
APPENDINO
CABIDE
HAKEN
KLEERHAAK
- 231 01 21**
\$ 300.00

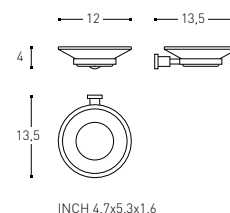

INCH 4.7x5.3x1.6

- ◆ JABONERA
SOAP DISH
PORTE-SAVON
PORTASAPONE
SABONETEIRA
SEIFENSCHALE
ZEEPBAKJE
- 231 01 32**
\$ 1,350.00

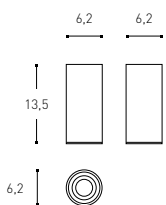

INCH 2.4x2.4x5.3

- PORTACEPILLOS ENCIMERA
FREE STANDING BRUSH-HOLDER
PORTE-BROSSE À DENTS À POSER
PORTASPAZZOLINI DA APPOGGIO
PORTA-ESCOVA DE DENTES DE BAN-
CADA
ZAHNBÜRSTENHALTER FÜR AUFLAGE
TANDENBORSTELHOUDER VOOR BLAD
- 205 01 51**
\$ 1,240.00

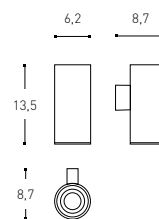

INCH 2.4x3.4x5.3

- PORTACEPILLOS
BRUSH-HOLDER
PORTE-BROSSE À DENTS
PORTASPAZZOLINI
PORTA-ESCOVA DE DENTES
ZAHNBÜRSTENHALTER
TANDENBORSTELHOUDER
- 205 01 53**
\$ 1,350.00

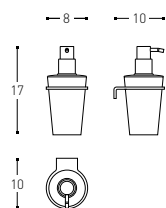

INCH 3.1x3.9x6.7

- △ DOSIFICADOR
SOAP DISPENSER
PORTE-SAVON LIQUIDE
DISPENSER
DISPENSADOR SABONETE
SEIFENSPENDER
DOSEERDER
- 226 02 05**
\$ 1,300.00

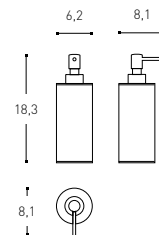

INCH 2.4x3.2x7.2

- DOSIFICADOR ENCIMERA
FREE STANDING SOAP DISPENSER
PORTE-SAVON LIQUIDE À POSER
DISPENSER DA APPOGGIO
DISPENSADOR SABONETE DE BAN-
CADA
AUFLAGESEIFENSPENDER
DOSEERDER VOOR BLAD
- 205 01 04**
\$ 1,370.00



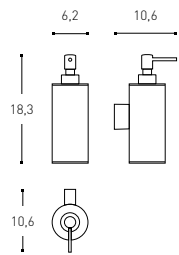

INCH 2.4x4.2x7.2

231 01 03
 DOSIFICADOR
 SOAP DISPENSER
 PORTE-SAVON LIQUIDE
 DISPENSER
 DISPENSADOR SABONETE
 SEIFENSPENDER
 DOSEERDER
205 01 03
\$ 1,460.00

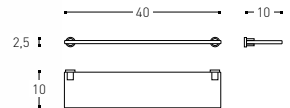

INCH 15.7x3.9x1

231 01 44
 ESTANTE VIDRIO
 GLASS FLAT SHELF
 TABLETTE VERRE
 MENSOLA VETRO
 PRATELEIRA VIDRO
 GLASABLAGE
 GLAZEN REK
231 01 44
\$ 1,600.00

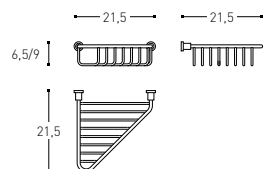

INCH 8.5x8.5x2.6/3.5

231 01 50 21,5x6,5 CM / INCH 8.5x2.6
\$ 1,510.00
231 01 89 21,5x9 CM / INCH 8.5x3.5
\$ 1,850.00

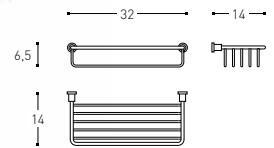

INCH 12.6x5.5x2.5

231 01 49
 CONTAINER
 CONTAINER
 PANIER
 CESTINO
 CONTÉINER
 WANDKORB
 REKJE
231 01 49
\$ 1,510.00

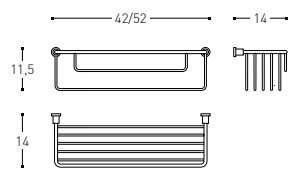

INCH 16.5/20.5x5.5x4.5

231 01 48 42 CM / INCH 16.5
\$ 1,870.00
231 01 88 52 CM / INCH 20.5
\$ 2,310.00

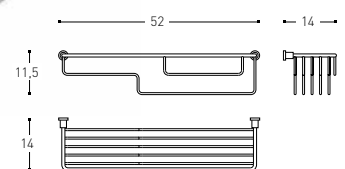
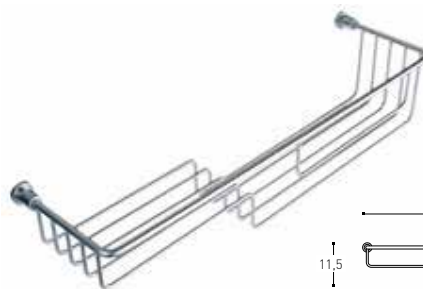

INCH 20.5x5.5x4.5

231 01 87
 CONTAINER ESCALÓN
 CONTAINER WITH STAGE
 PANIER ECHELON
 CESTINO SCALA
 CONTÉINER ESCALÃO
 WANDKORB MIT STUFE
 REKJE TWEE NIVEAUS
231 01 87
\$ 2,220.00

contract

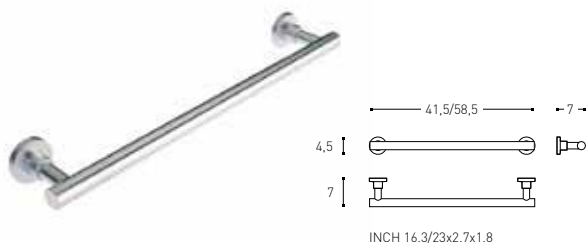

- TOALLERO
TOWEL RACK
PORTE - SERVIETTE
PORTASALVIETTE
TOALHEIRO
HANDTUCHSTANGE
HANDDOEKHOUDER

231 01 64 41,5 CM / INCH 16.3

\$ 1,260.00

231 01 65 58,5 CM / INCH 23

\$ 1,330.00



- TOALLERO ARO
TOWEL RING
PORTE - SERVIETTE ANNEAU
PORTASALVIETTE ANELLO
TOALHEIRO ARGOLA
HANDTUCHRING
HANDDOEKRING

231 01 71 Ø 16 CM / INCH Ø 6.3

\$ 1,070.00

231 01 72 Ø 21 CM / INCH Ø 8.3

\$ 1,130.00

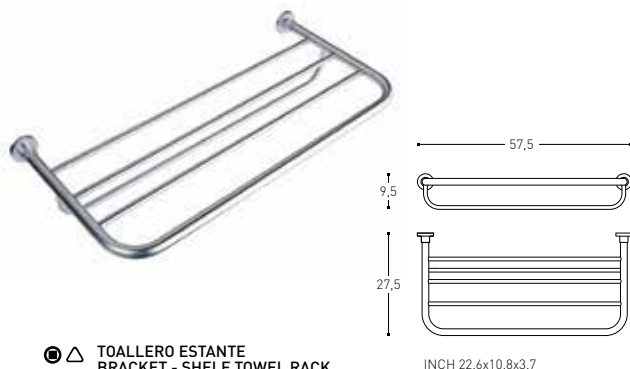

- TOALLERO ESTANTE
BRACKET - SHELF TOWEL RACK
PORTE - LINGE DE BAIN
PORTASALVIETTE MENSOLA
TOALHEIRO PRATELEIRA
HANDTUCHABLAGE
HANDDOEKREK

231 01 68

\$ 3,310.00



- PORTAPAPEL CON TAPA
PAPER HOLDER WITH COVER
PORTE - ROULEAUX COUVERT
PORTAROTOLO CON COPERCHIO
PORTA - ROLO COM TAMPA
ROLLENHALTER MIT DECKEL
TOILETROLHOUDER MET KLEP

231 01 59

\$ 1,040.00



- PORTAPAPEL SIN TAPA
PAPER HOLDER WITHOUT COVER
PORTE - ROULEAUX SANS COUVERCLE
PORTAROTOLO SENZA COPERCHIO
PORTA - ROLO SEM TAMPA
ROLLENHALTER OHNE DECKEL
TOILETROLHOUDER ZONDER KLEP

231 01 58

\$ 810.00



- ESCOBILLERO
TOILET BRUSH
PORTE - BALAYETTE
PORTASCOPINO
PORTA - PIAÇABA
TOILETTENBÜRSTENHALTER
WC - BORSTELHOUDER

231 01 00

\$ 2,130.00



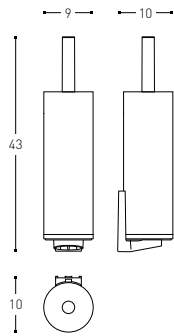

INCH 3.5x3.9x16.9



ESCOBILLERO SUELO / PARED
TOILET BRUSH FLOOR / WALL
PORTE - BALAYETTE SOL / MUR
PORTASCOPINO A TERRA / MURO
PORTA - PIAÇABA SOLO / PAREDE
TOILETTENBÜRSTENHALTER BODEN / WAND
WC - BORSTELHOUDER VLOER / MUUR

251 01 00
\$ 2,720.00



contract

recambios spare parts pièces détachées ricambi peças de reposição ersatzteile reserveonderdelen

ACCESORIO SUJECIÓN PARED / WALL MOUNTING SET / KIT FIXATION MURALE / ACCESSORIO FISSAGGIO MURO / CONJUNTO FIXAÇÃO PAREDE / WANDFIXIERUNGSSET / MONTAGESET WAND

330 88 00 \$ 140.00

RECAMBIO DE / SPARE PART OF / PIÈCE DÉTACHÉE DE / RICAMBIO DI / PEÇA DE REPOSIÇÃO DE / ERSATZTEIL FÜR / ONDERDEEL VAN 2310161, 2310164, 2310165, 2310166

ACCESORIO SUJECIÓN BÁSICO / BASIC MOUNTING SET / KIT FIXATION DE BASE / ACCESSORIO FISSAGGIO BASE / CONJUNTO FIXAÇÃO BASICO / STANDARD FIXIERUNGSSET / MONTAGESET FUNDAMENTEEL

341 00 18 \$ 120.00

RECAMBIO DE / SPARE PART OF / PIÈCE DÉTACHÉE DE / RICAMBIO DI / PEÇA DE REPOSIÇÃO DE / ERSATZTEIL FÜR / ONDERDEEL VAN 2310144, 2310145

ACCESORIO SUJECIÓN CONTAINER / CONTAINER MOUNTING SET / KIT FIXATION CONTAINER / KIT COMPLETO FISSAGGIO A MURO CESTINO / CONJUNTO FIXAÇÃO PAREDE EMBELEZADOR / WANDKORB FIXIERUNGSSET / MONTAGESET REKJE

341 00 66 \$ 320.00

RECAMBIO DE / SPARE PART OF / PIÈCE DÉTACHÉE DE / RICAMBIO DI / PEÇA DE REPOSIÇÃO DE / ERSATZTEIL FÜR / ONDERDEEL VAN 2310132, 2310148, 2310149, 2310150, 2310152, 2310187, 2310188, 2310189

ACCESORIO SOPORTE PARED CON EMBELECEDOR / WALL MOUNTING SET WITH FLANGE / KIT FIXATION MURALE AVEC ENJOLIVEUR / ACCESSORIO FISSAGGIO A MURO CON BORCHIA / CONJUNTO SUPORTE PAREDE COM EMBELEZADOR / WANDFIXIERUNGSSET MIT ROSETTE / MONTAGESET WAND MET SIERKNOP

341 00 49 \$ 320.00

RECAMBIO DE / SPARE PART OF / PIÈCE DÉTACHÉE DE / RICAMBIO DI / PEÇA DE REPOSIÇÃO DE / ERSATZTEIL FÜR / ONDERDEEL VAN 2310158, 2310159, 2310161, 2310164, 2310165, 2310166, 2310168, 2310171, 2310172, 2310175

JUEGO BIS SUJECIÓN (M5/M6) / SCREW MOUNTING SET (M5/M6) / SET VIS FIXATION (M5/M6) / KIT VITE FISSAGGIO (M5/M6) / CONJUNTO BIS FIXAÇÃO (M5/M6) / MADENSCHRAUBENSSET (M5/M6) / MONTAGESET (M5/M6)

330 91 00 \$ 60.00

JABONERA / SOAP DISH / PORTE-SAVON / PORTASAPONE / SABONETEIRA / SEIFENSCHALE / ZEEPBAKJE

330 60 00 Mate / Matte / Mat / Satinato / Mate / Matt / Mat \$ 460.00

RECAMBIO DE / SPARE PART OF / PIÈCE DÉTACHÉE DE / RICAMBIO DI / PEÇA DE REPOSIÇÃO DE / ERSATZTEIL FÜR / ONDERDEEL VAN 2310132

VASO / GLASS / VERRE / BICCHIERE / COPO / ZAHNPUTZBECHER / BEKER

330 27 31 Mate / Matte / Mat / Satinato / Mate / Matt / Mat \$ 300.00

RECAMBIO DE / SPARE PART OF / PIÈCE DÉTACHÉE DE / RICAMBIO DI / PEÇA DE REPOSIÇÃO DE / ERSATZTEIL FÜR / ONDERDEEL VAN 2310152

FRASCO DOSIFICADOR / SOAP DISPENSER FLASK / FLACON PORTE-SAVON / FLACONE DISPENSER / FRASCO DISPENSADOR / FLAKON SEIFENSPENDER / DOSEERFLACON

330 85 00 Mate / Matte / Mat / Satinato / Mate / Matt / Mat \$ 590.00

RECAMBIO DE / SPARE PART OF / PIÈCE DÉTACHÉE DE / RICAMBIO DI / PEÇA DE REPOSIÇÃO DE / ERSATZTEIL FÜR / ONDERDEEL VAN 2260205

PULSADOR + BOMBA DOSIFICADOR / DISPENSER PUSH BUTTON + PUMP / POUSSOIR + POMPE PORTE-SAVON LIQUIDE / PULSANTE + POMPETTA DISPENSER / BOTÃO + BOMBA DOSEADOR / PUMPENKOPF FÜR SEIFENSPENDER / DRUKKNOP + POMP VERDELER VLOEIBARE ZEEP

341 06 15 \$ 310.00

RECAMBIO DE / SPARE PART OF / PIÈCE DÉTACHÉE DE / RICAMBIO DI / PEÇA DE REPOSIÇÃO DE / ERSATZTEIL FÜR / ONDERDEEL VAN 2050104, 2050103

BOMBA DOSIFICADOR / DISPENSER PUMP / POMPE PORTE-SAVON LIQUIDE / POMPETTA DISPENSER / BOMBA DISPENSADOR / DOSIERPUMPE SEIFENSPENDER / DOSEERPOMPJE

341 06 22 \$ 140.00

RECAMBIO DE / SPARE PART OF / PIÈCE DÉTACHÉE DE / RICAMBIO DI / PEÇA DE REPOSIÇÃO DE / ERSATZTEIL FÜR / ONDERDEEL VAN 2050104, 2050103

ESTANTE / SHELF / TABLETTE / MENSOLA / PRATELEIRA / ABLAGE / REK

40 CM / INCH 15.7

330 35 30 Mate / Matte / Mat / Satinato / Mate / Matt / Mat \$ 630.00

RECAMBIO DE / SPARE PART OF / PIÈCE DÉTACHÉE DE / RICAMBIO DI / PEÇA DE REPOSIÇÃO DE / ERSATZTEIL FÜR / ONDERDEEL VAN 2310144

57,5 CM / INCH 22.6

330 31 30 Mate / Matte / Mat / Satinato / Mate / Matt / Mat \$ 1,350.00

RECAMBIO DE / SPARE PART OF / PIÈCE DÉTACHÉE DE / RICAMBIO DI / PEÇA DE REPOSIÇÃO DE / ERSATZTEIL FÜR / ONDERDEEL VAN 2310145

VASO ESCOBILLERO / TOILET BRUSH GLASS / VERRE PORTE-BALAYETTE / BICCHIERE PORTASCPINO / COPO PORTA-PIAÇABA / GLAS TOILETTENBÜRSTENHALTER / WC-BORSTELHOUDERPOT

330 83 00 Mate / Matte / Mat / Satinato / Mate / Matt / Mat \$ 500.00

RECAMBIO DE / SPARE PART OF / PIÈCE DÉTACHÉE DE / RICAMBIO DI / PEÇA DE REPOSIÇÃO DE / ERSATZTEIL FÜR / ONDERDEEL VAN 2310100

PALO ESCOBILLERO CON CEPILLO / TOILET BRUSH STICK WITH BRUSH / MANCHE BALAYETTE AVEC BROSSE / MANICO SCOPINO CON SPAZZOLINO / ESCOVA COM CABO PORTA-PIAÇABA / TOILETTENBÜRSTEL MIT GRIFF / HANDVAT MET BORSTEL

340 04 01 \$ 700.00

RECAMBIO DE / SPARE PART OF / PIÈCE DÉTACHÉE DE / RICAMBIO DI / PEÇA DE REPOSIÇÃO DE / ERSATZTEIL FÜR / ONDERDEEL VAN 2310100

340 90 17 \$ 840.00

RECAMBIO DE / SPARE PART OF / PIÈCE DÉTACHÉE DE / RICAMBIO DI / PEÇA DE REPOSIÇÃO DE / ERSATZTEIL FÜR / ONDERDEEL VAN 2510100

CEPILLO ESCOBILLERO / TOILET BRUSH BRUSH / BROSSE PORTE-BALAYETTE / SPAZZOLINO PORTASCPINO / ESCOVA PARA PIAÇABA / TOILETTENBÜRSTENKOPF / BORSTEL WC-BORSTELHOUDER

350 11 00 Blanco / White / Blanc / Bianco / Branco / Weiss / Wit \$ 280.00

341 03 13 Negro / Black / Noir / Nero / Preto / Schwarz / Zwart \$ 280.00

RECAMBIO DE / SPARE PART OF / PIÈCE DÉTACHÉE DE / RICAMBIO DI / PEÇA DE REPOSIÇÃO DE / ERSATZTEIL FÜR / ONDERDEEL VAN 2310100, 2510100

TACO PLADUR / DRYWALL ANCHOR / CHEVILLE PLACOPLÂTRE / TASSELLO CARTONGESSO / TACO PLADUR / DÜBEL FÜR RIGIPS-PLATTEN / GIPSPLAAT PLUG

341 06 36 \$ 150.00

RECAMBIO DE / SPARE PART OF / PIÈCE DÉTACHÉE DE / RICAMBIO DI / PEÇA DE REPOSIÇÃO DE / ERSATZTEIL FÜR / ONDERDEEL VAN 2310100, 2310121, 2310132, 2310144, 2310148, 2310149, 2310150, 2310158, 2310159, 2310164, 2310165, 2310168, 2310171, 2310172, 2310187, 2310188, 2310189



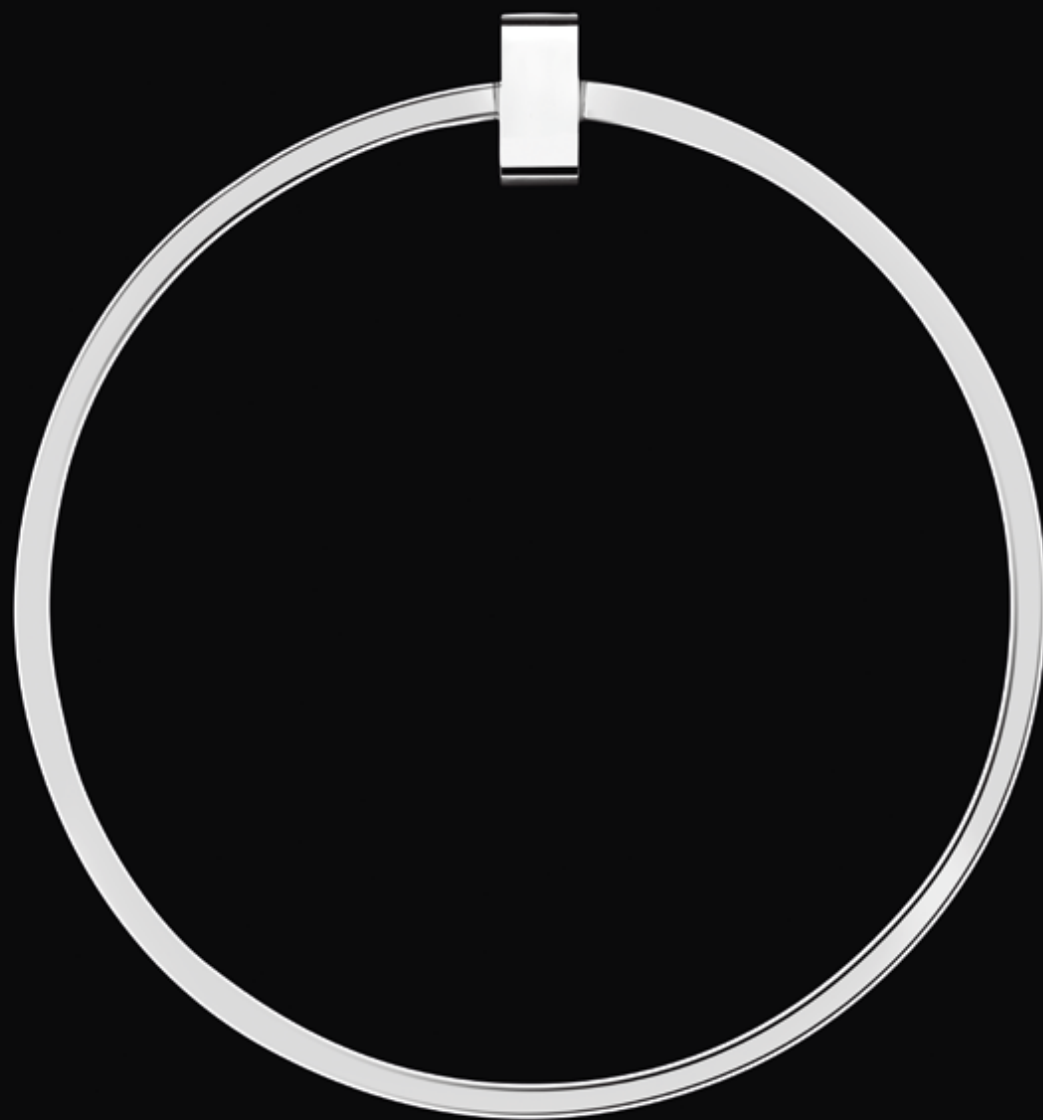

Sereno **equilibrio** entre
la sobria **elegancia** de
las líneas rectangulares y la
sensualidad que desprenden
sus suaves **curvas**.

*Serene **balance** between sober
elegance of rectangular lines
and the **sensuality** released
by its smooth **curves***

ex treme

DESIGN BY COSMIC STUDIO

extreme



Características

Fácil instalación: tornillo de doble paso.
Fijaciones ocultas. Anticorrosión.
Estante de vidrio templado (alta seguridad).

Features

*Easy installation: double pitch screw.
Hidden attachments. Anti-corrosion.
Tempered glass shelf (high safety).*

Caractéristiques :

Facile installation : vis à double pas.
Fixations occultes. Anti-corrosion.
Tablette de verre trempé (haute sécurité).

Caratteristiche:

*Facile installazione : vite a doppio passo.
Fissaggio nascosto. Anticorrosivo. Mensola
di vetro temperato (alta sicurezza).*

Características:

Fácil instalação: parafuso de dupla
passagem. Fixações ocultas.
Anti-corrosão. Estante de vidro temperado
(alta segurança).

Eigenschaften:

*Einfache montage: doppel-pass-schraube.
Unsichtbare Befestigungen. Korrosionsschutz.
Ablage aus gehärtetem Sicherheitsglas.*

Kenmerken:

Eenvoudig te monteren: schroef met
dubbele draad. Verborgene bevestigingen.
Corrosiewerend. Plank van gehard glas
(hoogbeveiligd).

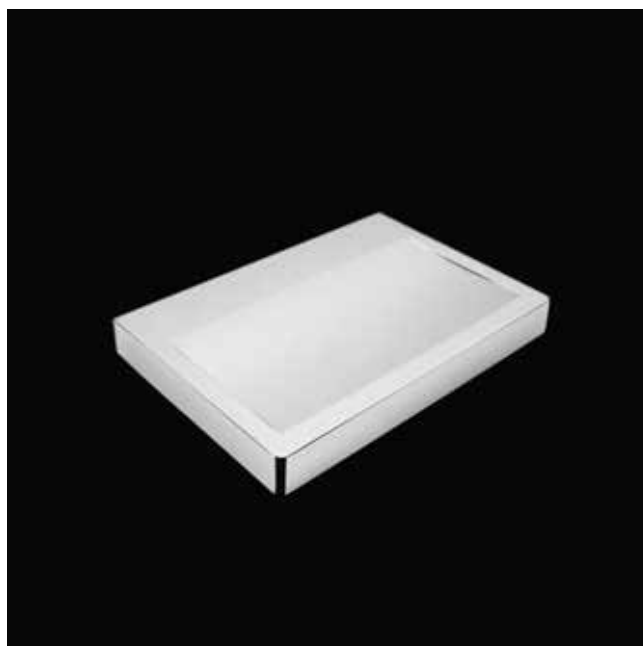

Acabados Finishes Finitions Finiture Acabamentos Oberflächen Afwerkingen



Cromo
Chrome
Chromé
Cromo
Cromo
Chrom
Verchromd



Cromo-negro
Chrome-black
Chrome-noir
Cromato-nero
Cromo-preto
Chrom-schwarz
Verchromd-zwart



extreme

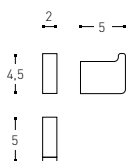

INCH 0.8x2x1.8

- COLGADOR
HANGER
PATÈRE
APPENDINO
CABIDE
HAKEN
KLEERHAAK
- 253 01 21**
\$ 790.00

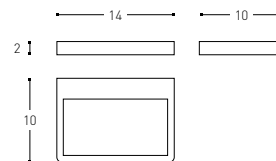

INCH 5.5x3.9x0.8

- JABONERA
SOAP DISH
PORTE-SAVON
PORTASAPONE
SABONETEIRA
SEIFENSCHALE
ZEEPBAKJE
- 253 01 32**
\$ 1,940.00

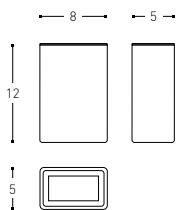

INCH 3.1x2x4.7

- △ PORTACEPILLOS ENCIMERA
FREE STANDING BRUSH-HOLDER
PORTE-BROSSE À DENTS À POSER
PORTASPAZZOLINI DA APPOGGIO
PORTA-ESCOVA BANCADA
ZAHNBÜRSTENHALTER FÜR AUFLAGE
TANDENBORSTELHOUDER VOOR BLAD
- 253 01 53**
\$ 1,760.00

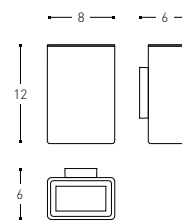

INCH 3.1x2.4x4.7

- △ PORTACEPILLOS
BRUSH-HOLDER
PORTE-BROSSE À DENTS
PORTASPAZZOLINI
PORTA-ESCOVA DE DENTES
ZAHNBÜRSTENHALTER
TANDENBORSTELHOUDER
- 253 01 52**
\$ 1,940.00

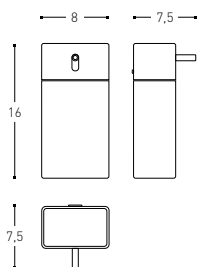

INCH 3.1x2.9x6.3

- △ DOSIFICADOR ENCIMERA
FREE STANDING SOAP DISPENSER
PORTE-SAVON LIQUIDE À POSER
DISPENSER DA APPOGGIO
DOSEADOR SABONETE BANCADA
AUFLAGESEIFENSPENDER
DOSEERDER VOOR BLAD
- 253 01 04**
\$ 2,440.00

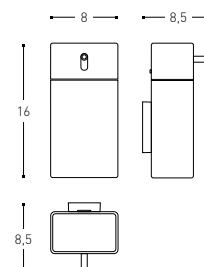

INCH 3.1x3.3x6.3

- △ DOSIFICADOR
SOAP DISPENSER
PORTE-SAVON LIQUIDE
DISPENSER
DOSEADOR SABONETE
SEIFENSPENDER
DOSEERDER
- 253 01 05**
\$ 2,580.00



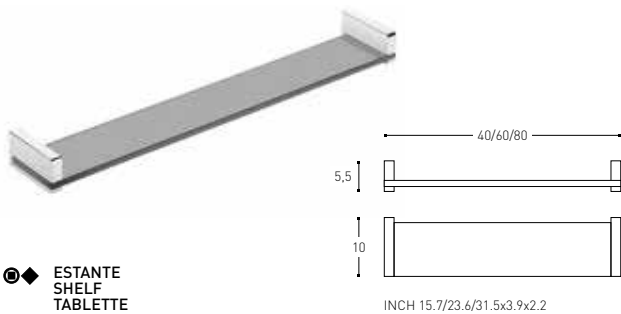

◆ ESTANTE
SHELF
TABLETTE
MENSOLA
PRATELEIRA
ABLAGE
REK

253 01 44 40 CM / INCH 15.7 \$ 1,940.00

253 01 45 60 CM / INCH 23.6 \$ 2,240.00

253 01 46 80 CM / INCH 31.5 \$ 2,580.00

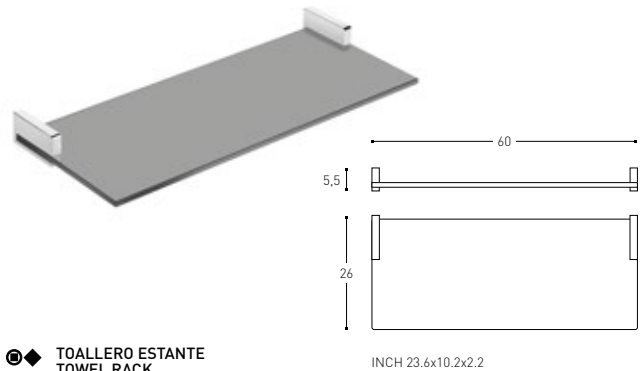

◆ TOALLERO ESTANTE
TOWEL RACK
PORTE-SERVLETTE TABLETTE
PORTASALVIETTE MENSOLA
TOALHEIRO PRATELEIRA
HANDTUCHABLAGE
HANDDOEKHOUDER REK

253 01 68 \$ 4,150.00

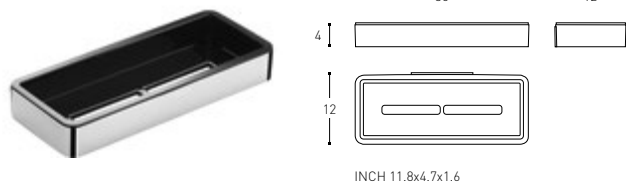

△ CONTAINER
CONTAINER
PANIER
CESTINO
SABONETEIRA
WANDKORB
REKJE

251 61 49 \$ 2,170.00

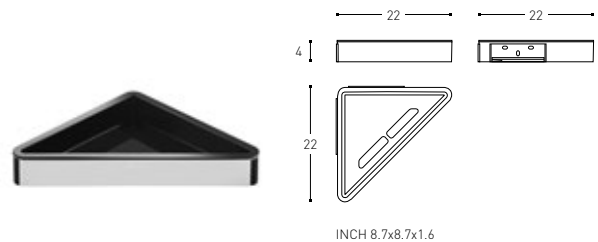

△ CONTAINER
CONTAINER
PANIER
CESTINO
SABONETEIRA
WANDKORB
REKJE

251 61 50 \$ 2,010.00

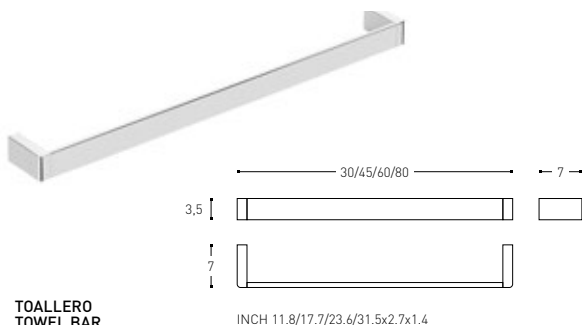

● TOALLERO
TOWEL BAR
PORTE-SERVLETTE
PORTASALVIETTE
TOALHEIRO
HANDTUCHSTANGE
HANDDOEKHOUDER

253 01 63 30 CM / INCH 11.8

\$ 1,760.00

253 01 64 45 CM / INCH 17.7

\$ 2,080.00

253 01 65 60 CM / INCH 23.6

\$ 2,440.00

253 01 66 80 CM / INCH 31.5

\$ 2,900.00

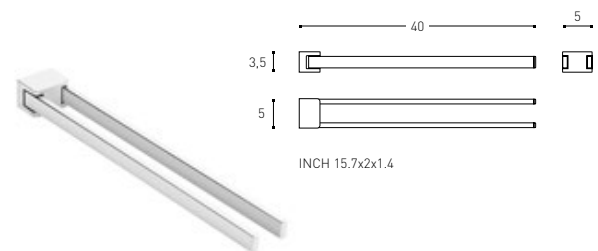

● TOALLERO GIRATORIO DOBLE
DOUBLE SWIVEL TOWEL RACK
PORTE-SERVLETTE PIVOTANT DOBLE
PORTASALVIETTE A SNODO DOPPIO
TOALHEIRO GIRATÓRIO DUPLA
DOPPELTE HANDTUCHSTANGE SCHWENKBAR
DUBBELE HANDDOEKHOUDER DRAAIBAAR

253 01 75 \$ 3,060.00

extreme

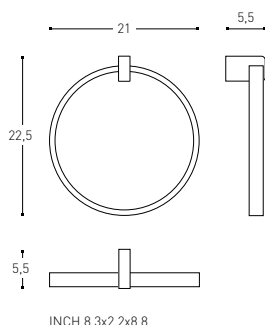

● TOALLERO ARO
TOWEL RING
PORTE-SERVIETTE ANNEAU
PORTASALVIETTE ANELLO
TOALHEIRO ARGOLA
HANDTUCHRING
HANDDOEKRING

253 01 71
\$ 2,080.00

INCH 8.3x2.2x8.8

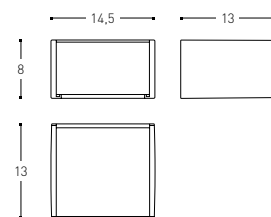

INCH 5.7x5.1x3.1

●△ PORTAPAPEL CON TAPA
PAPER-HOLDER WITH COVER
PORTE-ROULEAUX COUVERT
PORTAROTOLO CON COPERCHIO
PORTA-ROLO COM TAPA
ROLLENHALTER MIT DECKEL
TOILETROLHOUDER MET KLEP

251 01 59
\$ 1,870.00

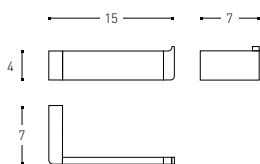

INCH 5.9x2.7x1.6

● PORTAPAPEL
PAPER-HOLDER
PORTE-ROULEAUX
PORTAROTOLO
PORTA-ROLO
ROLLENHALTER
TOILETROLHOUDER

253 01 58
\$ 1,440.00

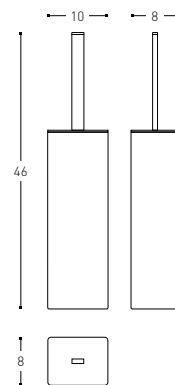

INCH 3.9x3.1x18.1

●△ ESCOBILLERO SUELO
FLOOR TOILET BRUSH
PORTE-BALAYETTE SOL
PORTASCOPINO A TERRA
PORTA-PIACABA SOLO
TOILETTENBÜRSTENHALTER BODEN
WC-BORSTELHOUDER VLOER

253 01 01
\$ 3,520.00

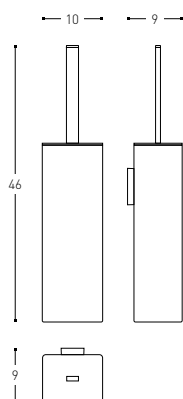

INCH 3.9x3.5x18.1

●△ ESCOBILLERO
TOILET BRUSH
PORTE-BALAYETTE
PORTASCOPINO
PORTA-PIACABA
TOILETTENBÜRSTENHALTER
WC-BORSTELHOUDER

253 01 00
\$ 3,840.00



extreme

recambios spare parts pièces detachées ricambi peças de reposição ersatzteile reserveonderdelen

ACCESORIO SUJECIÓN PARED ESTANTE/PORTATOALLAS / WALL FIXATION SET TOWEL RACK/SHELF / SET FIXATION MURALE TABLETTE PORTE-SERVLETTE TABLETTE / SET DI FISSAGGIO A MURO MENSOLA PORTASALVIETTE / CONJUNTO FIXAÇÃO PAREDE PRATELEIRA TOALHEIRO PRATELEIRA / WANDFIXIERUNGSSET ABLAGE HANDTUCHABLAGE / MUUR BEVESTIGINGSSET HANDDOEK REK

341 02 08 \$ 100.00

RECAMBIO DE / SPARE PART OF / PIÈCE DÉTACHÉE DE / RICAMBIO DI / PEÇA DE REPOSIÇÃO DE / ERSATZTEIL FÜR / ONDERDEEL VAN
2530144, 2530145, 2530146, 2530168

ACCESORIO SUJECIÓN PARED COLGADOR/PORTAPAPEL/TOALLERO/ TOALLERO ARO / WALL FIXATION SET HOOK/PAPER HOLDER/TOWEL BAR/TOWEL RING / SET FIXATION MURALE PATÈRE/PORTE-ROULEAUX/PORTE-SERVLETTE/PORTE-SERVLETTE ANNEAU / SET DI FISSAGGIO A MURO APPENDINO/PORTAROTOLO/ PORTASALVIETTE/PORTASALVIETTE ANELLO / CONJUNTO FIXAÇÃO PAREDE CABIDE/ PORTA-ROLO/TOALHEIRO/TOALHEIRO ARGOLA / WANDFIXIERUNGSSET HAKEN / ROLLENHALTER/HANDTUCHSTANGE / HANDTUCHRING / MUUR BEVESTIGINGSSET HAKEN/TOILETROLHOUDER HANDDOEKHOUDER HANDDOEKRING

341 02 09 \$ 100.00

RECAMBIO DE / SPARE PART OF / PIÈCE DÉTACHÉE DE / RICAMBIO DI / PEÇA DE REPOSIÇÃO DE / ERSATZTEIL FÜR / ONDERDEEL VAN
2530121, 2530158, 2530163, 2530164, 2530165, 2530166, 2530171

ACCESORIO SUJECIÓN PARED / WALL MOUNTING SET / KIT FIXATION MURALE / ACCESSORIO FISSAGGIO MURO / CONJUNTO FIXAÇÃO PAREDE / WANDFIXIERUNGSSET / MONTAGESET WAND

341 02 10 \$ 100.00

ACCESORIO SUJECIÓN PARED TOALLERO GIRATORIO / WALL FIXATION SET SWIVEL TOWEL BAR / SET FIXATION MURALE PORTE-SERVLETTE GIRATOIRE / SET DI FISSAGGIO A MURO PORTASALVIETTE A SNODO / CONJUNTO FIXAÇÃO PAREDE TOALHEIRO GIRATÓRIO / WANDFIXIERUNGSSET HANDTUCHSTANGE SCHWENKBAR / MUUR BEVESTIGINGSSET HANDDOEKHOUDER DRAAIBAAR

341 02 11 \$ 190.00

RECAMBIO DE / SPARE PART OF / PIÈCE DÉTACHÉE DE / RICAMBIO DI / PEÇA DE REPOSIÇÃO DE / ERSATZTEIL FÜR / ONDERDEEL VAN
2530175

ACCESORIO SUJECIÓN PLÁSTICO TRIPLE / TRIPLE PLASTIC MOUNTING SET / KIT TRIPLE FIXATION PLASTIQUE / ACCESSORIO TRIPLO FISSAGGIO IN PLASTICA / CONJUNTO FIXAÇÃO PLÁSTICO TRIPLO / KUNSTSTOFF DREIFACHFIXIERUNGSSET / TRIPLE PLASTIC MONTAGESET

341 01 25 \$ 120.00

RECAMBIO DE / SPARE PART OF / PIÈCE DÉTACHÉE DE / RICAMBIO DI / PEÇA DE REPOSIÇÃO DE / ERSATZTEIL FÜR / ONDERDEEL VAN
2530132

BOMBA DOSIFICADOR / DISPENSER PUMP / POMPE PORTE-SAVON LIQUIDE / POMPETTA DISPENSER / BOMBA DISPENSADOR / DOSIERPUMPE SEIFENSPENDER / DOSEERPOMPJE

341 06 22 \$ 140.00

RECAMBIO DE / SPARE PART OF / PIÈCE DÉTACHÉE DE / RICAMBIO DI / PEÇA DE REPOSIÇÃO DE / ERSATZTEIL FÜR / ONDERDEEL VAN
2530104, 2530105

ESTANTE / SHELF / TABLETTE / MENSOLA / PRATELEIRA / ABLAGE / REK

40 CM / INCH 15.7

341 02 02 Fumé / Smoked / Fumé / Fumé / Fumado / Smoked / Rauchglas \$ 1,070.00

RECAMBIO DE / SPARE PART OF / PIÈCE DÉTACHÉE DE / RICAMBIO DI / PEÇA DE REPOSIÇÃO DE / ERSATZTEIL FÜR / ONDERDEEL VAN
2530144

60 CM / INCH 23.6

341 02 03 Fumé / Smoked / Fumé / Fumé / Fumado / Smoked / Rauchglas \$ 1,190.00

RECAMBIO DE / SPARE PART OF / PIÈCE DÉTACHÉE DE / RICAMBIO DI / PEÇA DE REPOSIÇÃO DE / ERSATZTEIL FÜR / ONDERDEEL VAN
2530145

80 CM / INCH 31.5

341 02 04 Fumé / Smoked / Fumé / Fumé / Fumado / Smoked / Rauchglas \$ 1,330.00

RECAMBIO DE / SPARE PART OF / PIÈCE DÉTACHÉE DE / RICAMBIO DI / PEÇA DE REPOSIÇÃO DE / ERSATZTEIL FÜR / ONDERDEEL VAN
2530146

ESTANTE TOALLERO ESTANTE / TOWEL RACK SHELF / TABLETTE PORTE-SERVLETTE TABLETTE / MENSOLA PORTASALVIETTE MENSOLA / PRATELEIRA TOALHEIRO PRATELEIRA / ABLAGE FÜR HANDTUCHABLAGE / REK HANDDOEKHOUDER REK

341 02 05 Fumé / Smoked / Fumé / Fumé / Fumado / Smoked / Rauchglas \$ 1,460.00

RECAMBIO DE / SPARE PART OF / PIÈCE DÉTACHÉE DE / RICAMBIO DI / PEÇA DE REPOSIÇÃO DE / ERSATZTEIL FÜR / ONDERDEEL VAN
2530168

PALO ESCOBILLERO CON CEPILLO / TOILET BRUSH STICK WITH BRUSH / MANCHE BALAYETTE AVEC BROsse / MANICO SCOPINO CON SPAZZOLINO / ESCOVA COM CABO PORTA-PIAÇABA / TOILETTENBÜRSTE MIT GRIFF / HANDVAT MET BORSTEL

341 02 06 \$ 970.00

RECAMBIO DE / SPARE PART OF / PIÈCE DÉTACHÉE DE / RICAMBIO DI / PEÇA DE REPOSIÇÃO DE / ERSATZTEIL FÜR / ONDERDEEL VAN
2530100, 2530101

CEPILLO ESCOBILLERO / TOILET BRUSH BRUSH / BROsse PORTE-BALAYETTE / SPAZZOLINO PORTASCOPINO / ESCOVA PARA PIAÇABA / TOILETTENBÜRSTENKOPF / BORSTEL WC-BORSTELHOUDER

350 11 00 Blanco / White / Blanc / Bianco / Branco / Weiss / Wit \$ 280.00

341 03 13 Negro / Black / Noir / Nero / Preto / Schwarz / Zwart \$ 280.00

RECAMBIO DE / SPARE PART OF / PIÈCE DÉTACHÉE DE / RICAMBIO DI / PEÇA DE REPOSIÇÃO DE / ERSATZTEIL FÜR / ONDERDEEL VAN
2530100, 2530101

PULSADOR + BOMBA DOSIFICADOR / DISPENSER PUSH BUTTON + PUMP / POUSSOIR + POMPE PORTE-SAVON LIQUIDE / PULSANTE + POMPETTA DISPENSER / BOTÃO + BOMBA DOSEADOR / PUMPENKOPF FÜR SEIFENSPENDER / DRUKKNOP + POMP VERDELER VLOEIBARE ZEEP

341 06 57 \$ 1,370.00

RECAMBIO DE / SPARE PART OF / PIÈCE DÉTACHÉE DE / RICAMBIO DI / PEÇA DE REPOSIÇÃO DE / ERSATZTEIL FÜR / ONDERDEEL VAN
2530104, 2530105

TACO PLADUR / DRYWALL ANCHOR / CHEVILLE PLACOPLÂTRE / TASSELLO CARTONGESSO / TACO PLADUR / DÜBEL FÜR RIGIPS-PLATTEN / GIPSLAAT PLUG

341 06 36 \$ 150.00

RECAMBIO DE / SPARE PART OF / PIÈCE DÉTACHÉE DE / RICAMBIO DI / PEÇA DE REPOSIÇÃO DE / ERSATZTEIL FÜR / ONDERDEEL VAN
2530100, 2530105, 2530121, 2530132, 2530144, 2530145, 2530146, 2530152, 2530158, 2530163, 2530164, 2530165, 2530166, 2530168, 2530171, 2530175



La **resistencia** del acero
se une a las formas más
contemporáneas
dando como resultado piezas
extremadamente **sobrias**
y **elegantes**.

*The **resistance** of
steel combines with the most
contemporary forms
resulting in intensely **sober**
and **elegant** pieces.*

inox
DESIGN BY COSMIC STUDIO

inox

Codificación / Code /
Codification / Codice / Codificação /
Kodifizierung / Codificatie

225 AA 21

COLECCIÓN / COLLECTION / COLLECTION /
COLLEZIONE / COLEÇÃO / KOLLEKTION / COLLECTIE

ACABADOS / FINISHES / FINITIONS / FINITURE / ACABAMENTOS /
OBERFLÄCHEN / AFWERKINGEN

MODELO / TYPE / MODÈLE / MODEL / MODELO / MODELL / MODEL



Características

Fácil instalación: tornillo de doble paso.
Fijaciones ocultas. Anticorrosión.

Features

*Easy installation: double pitch screw.
Hidden attachments. Anti-corrosion.*

Caractéristiques :

Facile installation : vis à double pas.
Fixations occultes. Anti-corrosion.

Caratteristiche:

*Facile installazione : vite a doppio passo.
Fissaggio nascosto. Anticorrosivo.*

Características:

Fácil instalação: parafuso de dupla
passagem. Fixações ocultas. Anti-corrosão.

Eigenschaften:

*Einfache montage: doppel-pass-schraube.
Unsichtbare Befestigungen. Korrosionsschutz.*

Kenmerken:

Eenvoudig te monteren: schroef met
dubbele draad. Verborgen bevestigingen.
Corrosiewerend.

Acabados

Finishes

Finitions

Finiture

Acabamentos

Oberflächen

Afwerkingen



02

Brillo
Bright
Brillant
Lucido
Brilho
Glänzend
Glanzend



03

Mate
Matte
Mat
Satinato
Mate
MattMat

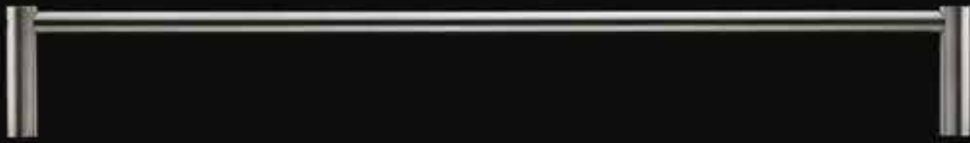

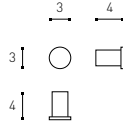

INCH 1.2x1.6x1.2

- COLGADOR
HANGER
PATERE
APPENDINO
CABIDE
HAKEN
KLEERHAAK

225 AA 21
\$ 540.00

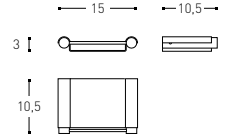

INCH 5.9x4.1x1.2

- JABONERA
SOAP DISH
PORTE-SAVON
PORTASAPONE
SABONETEIRA
SEIFENSCHALE
ZEEPABAKJE

225 AA 32
\$ 1,460.00

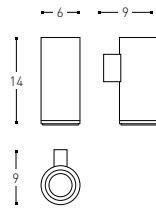

INCH 2.7x3.5x5.5

- △ PORTACEPILLOS
BRUSH-HOLDER
PORTE-BROSSE À DENTS
PORTASPAZZOLINI
PORTA-ESCOVA DE DENTES
ZAHNBÜRSTENHALTER
TANDENBORSTELHOUDER

226 AA 03
\$ 1,370.00

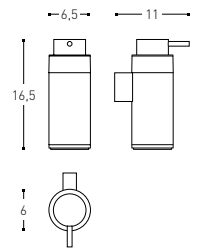

INCH 2.5x4.3x6.5

- △ DOSIFICADOR
SOAP DISPENSER
PORTE-SAVON LIQUIDE
DISPENSER
DOSEADOR SABONETE
SEIFENSPENDER
DOSEERDER

226 AA 04
\$ 1,370.00

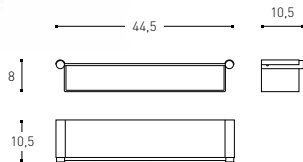

INCH 17.5x4.1x3.1

- ESTANTE
FLAT SHELF
TABLETTE
MENSOLA
PRATELEIRA
ABLAGE
REK

225 AA 46
\$ 2,000.00

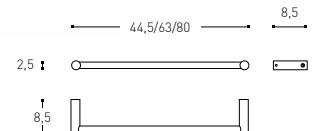

INCH 17.5/24.8/31.5x3.3x1

- TOALLERO
TOWEL RACK
PORTE - SERVIETTE
PORTASALVIETTE
TOALHEIRO
HANDTUCHSTANGE
HANDDOEKHOUDER

225 AA 64 44,5 CM / INCH 17.5

\$ 1,530.00

225 AA 65 63 CM / INCH 24.8

\$ 1,690.00



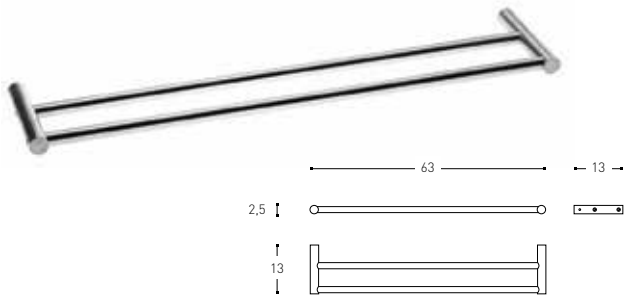

- TOALLERO DOBLE
DOUBLE TOWEL RACK
PORTE - SERVIETTE DOUBLE
PORTASALVIETTE DOPPIO
TOALHEIRO DUPLIO
DOPPELLE HANDTUCHSTANGE
DUBBEL HANDDOEKHOUDER

225 AA 61
\$ 2,670.00

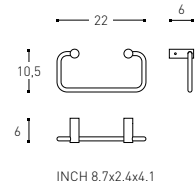

- TOALLERO ARO
TOWEL RING
PORTE - SERVIETTE ANNEAU
PORTASALVIETTE ANELLO
TOALHEIRO ARGOLA
HANDTUCHRING
HANDDOEKRING

225 AA 71 10,5 CM / INCH 4.1
\$ 1,530.00

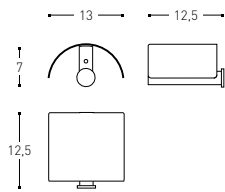

- PORTAPAPEL CON TAPA
PAPER HOLDER WITH COVER
PORTE - ROULEAUX COUVERT
PORTAROTOLO CON COPERCHIO
PORTA - ROLO COM TAMPA
ROLLENHALTER MIT DECKEL
TOILETROLHOUDER MET KLEP

225 AA 59
\$ 1,280.00

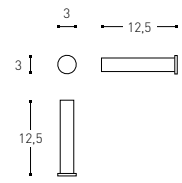

- PORTAPAPEL SIN TAPA
PAPER HOLDER WITHOUT COVER
PORTE - ROULEAUX SANS COUVERCLE
PORTAROTOLO SENZA COPERCHIO
PORTA - ROLO SEM TAMPA
ROLLENHALTER OHNE DECKEL
TOILETROLHOUDER ZONDER KLEP

225 AA 58
\$ 880.00

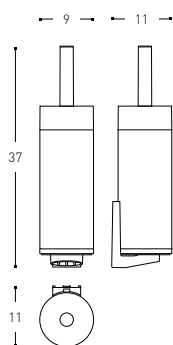

- △

ESCOBILLERO SUELO / PARED
TOILET BRUSH FLOOR / WALL
PORTE BALAYETTE SOL / MUR
PORTASCPINO A TERRA / MURO
PORTA-PIACABA SOLO / PAREDE
TOILETTENBÜRSTENHALTER BODEN / WAND
WC-BORSTELHOUDER VLOER / MUUR

249 98 00 NEGRO-MATE / BLACK-MATTE
\$ 1,620.00

249 96 00 NEGRO-BRILLO / BLACK-GLOSSY
\$ 1,620.00

ACCESORIO SUJECIÓN PARED (1 TORNILLO) / WALL MOUNTING SET (1 SCREW) / KIT FIXATION MURALE (1 VIS) / ACCESSORIO FISSAGGIO MURO (1 VITE) / CONJUNTO FIXAÇÃO PAREDE (1 PARAFUSO) / WANDFIXIERUNGSSET (1 SCHRAUBE) / MONTAGESET WAND (1 SCHROEF)

330 86 00 \$ 140.00

RECAMBIO DE / SPARE PART OF / PIÈCE DÉTACHÉE DE / RICAMBIO DI / PEÇA DE REPOSIÇÃO DE / ERSATZTEIL FÜR / ONDERDEEL VAN 2250261, 2250264, 2250265, 2250266, 2250361, 2250364, 2250365, 2250366

ACCESORIO SUJECIÓN PORTAPAPEL / PAPER HOLDER MOUNTING SET / KIT FIXATION PORTE-ROULEAUX / ACCESSORIO FISSAGGIO PORTAROTOLO / CONJUNTO FIXAÇÃO PORTA-ROLO / ROLLENHALTER FIXIERUNGSSET / MONTAGESET TOILETROLHOUDER

341 00 07 \$ 520.00

RECAMBIO DE / SPARE PART OF / PIÈCE DÉTACHÉE DE / RICAMBIO DI / PEÇA DE REPOSIÇÃO DE / ERSATZTEIL FÜR / ONDERDEEL VAN 2250259, 2250359

ACCESORIO SUJECIÓN PARED COLGADOR/PORTAPAPEL / WALL FIXATION SET HOOK/PAPER HOLDER / SET FIXATION MURALE PATÈRE/PORTE-ROULEAUX / SET DI FISSAGGIO A MURO APPENDINO/PORTAROTOLO / CONJUNTO FIXAÇÃO PAREDE CABIDE/PORTA-ROLO / WANDFIXIERUNGSSET HAKEN/ROLLENHALTER / MUUR BEVESTIGINGSSET HAKEN/TOILETROLHOUDER

341 06 12 \$ 310.00

RECAMBIO DE / SPARE PART OF / PIÈCE DÉTACHÉE DE / RICAMBIO DI / PEÇA DE REPOSIÇÃO DE / ERSATZTEIL FÜR / ONDERDEEL VAN 2250221, 2250258, 2250321, 2250358

ACCESORIO SUJECIÓN PARED / WALL MOUNTING SET / KIT FIXATION MURALE / ACCESSORIO FISSAGGIO MURO / CONJUNTO FIXAÇÃO PAREDE / WANDFIXIERUNGSSET / MONTAGESET WAND

330 84 00 \$ 120.00

RECAMBIO DE / SPARE PART OF / PIÈCE DÉTACHÉE DE / RICAMBIO DI / PEÇA DE REPOSIÇÃO DE / ERSATZTEIL FÜR / ONDERDEEL VAN 2250200, 2250232, 2250245, 2250246, 2250252, 2250271, 2250272, 2250300, 2250332, 2250345, 2250346, 2250352, 2250371, 2250372

ACCESORIO SUJECIÓN PARED REDONDO / ROUND WALL MOUNTING SET / KIT FIXATION MURALE ROND / ACCESSORIO FISSAGGIO MURO ROTONDO / CONJUNTO FIXAÇÃO PAREDE REDONDO / WANDFIXIERUNGSSET RUND / MONTAGESET WAND ROND

330 76 00 \$ 140.00

RECAMBIO DE / SPARE PART OF / PIÈCE DÉTACHÉE DE / RICAMBIO DI / PEÇA DE REPOSIÇÃO DE / ERSATZTEIL FÜR / ONDERDEEL VAN 2250268

EMBELECEDOR / FLANGE / ENJOLIVEUR / BORCHIA / EMBELEZADOR / ROSSETTE / EMBELLISHER

341 06 13 Mate / Matte / Mat / Satinado / Mate / Matt / Mat \$ 260.00

RECAMBIO DE / SPARE PART OF / PIÈCE DÉTACHÉE DE / RICAMBIO DI / PEÇA DE REPOSIÇÃO DE / ERSATZTEIL FÜR / ONDERDEEL VAN 2250368

JUEGO BIS SUJECIÓN (M5/M6) / SCREW MOUNTING SET (M5/M6) / SET VIS FIXATION (M5/M6) / KIT VITE FISSAGGIO (M5/M6) / CONJUNTO BIS FIXAÇÃO (M5/M6) / MADENSCHRAUBENSSET (M5/M6) / MONTAGESET (M5/M6)

330 91 00 \$ 60.00

VASO / GLASS / VERRE / BICCHIERE / COPO / ZAHNPUTZBECHER / BEKER

330 27 31 Mate / Matte / Mat / Satinado / Mate / Matt / Mat \$ 300.00

RECAMBIO DE / SPARE PART OF / PIÈCE DÉTACHÉE DE / RICAMBIO DI / PEÇA DE REPOSIÇÃO DE / ERSATZTEIL FÜR / ONDERDEEL VAN 2250252, 2250352

POUSSOIR + POMPE PORTE-SAVON LIQUIDE / PULSANTE + POMPETTA DISPENSER / BOTÃO + BOMBA DOSEADOR / PUMPENKOPF FÜR SEIFENSPENDER / DRUKKNOP + POMP VERDELER VLOEIBARE ZEEP

341 01 13 Negro-Brillo / Black-Glossy / Noir-Brillant / Nero-Lucido / Preto-Brilho / Schwarz-Glänzend / Zwart-Glanzend \$ 650.00

RECAMBIO DE / SPARE PART OF / PIÈCE DÉTACHÉE DE / RICAMBIO DI / PEÇA DE REPOSIÇÃO DE / ERSATZTEIL FÜR / ONDERDEEL VAN 2260204

341 01 15 Negro-Mate / Black-Matte / Noir-Mat / Nero-Satinato / Preto-Mate / Schwarz-Matt / Zwart-Mat Verzilverd \$ 650.00

RECAMBIO DE / SPARE PART OF / PIÈCE DÉTACHÉE DE / RICAMBIO DI / PEÇA DE REPOSIÇÃO DE / ERSATZTEIL FÜR / ONDERDEEL VAN 2260304

BOMBA DOSIFICADOR / DISPENSER PUMP / POMPE PORTE-SAVON LIQUIDE / POMPETTA DISPENSER / BOMBA DISPENSADOR / DOSIERPUMPE SEIFENSPENDER / DOSEERPOMPE

341 06 22 \$ 140.00

RECAMBIO DE / SPARE PART OF / PIÈCE DÉTACHÉE DE / RICAMBIO DI / PEÇA DE REPOSIÇÃO DE / ERSATZTEIL FÜR / ONDERDEEL VAN 2260204, 2260304

VASO ESCOBILLERO / TOILET BRUSH GLASS / VERRE PORTE-BALAYETTE / BICCHIERE PORTASCOPINO / COPO PORTA-PIAÇABA / GLAS TOILETTENBÜRSTENHALTER / WC-BORSTELHOUDERPOT

330 83 00 Mate / Matte / Mat / Satinado / Mate / Matt / Mat \$ 500.00

RECAMBIO DE / SPARE PART OF / PIÈCE DÉTACHÉE DE / RICAMBIO DI / PEÇA DE REPOSIÇÃO DE / ERSATZTEIL FÜR / ONDERDEEL VAN 2250200, 2250300

PALO ESCOBILLERO CON CEPILLO / TOILET BRUSH STICK WITH BRUSH / MANCHE BALAYETTE AVEC BROUSSE / MANICO SCOPINO CON SPAZZOLINO / ESCOVA COM CABO PORTA-PIAÇABA / TOILETTENBÜRSTE MIT GRIFF / HANDVAT MET BORSTEL

341 00 42 Brillo / Glossy / Brillant / Lucido / Briho / Glänzend / Glanzend \$ 860.00

RECAMBIO DE / SPARE PART OF / PIÈCE DÉTACHÉE DE / RICAMBIO DI / PEÇA DE REPOSIÇÃO DE / ERSATZTEIL FÜR / ONDERDEEL VAN 2250200,

341 00 43 Mate / Matte / Mat / Satinado / Mate / Matt / Mat \$ 860.00

RECAMBIO DE / SPARE PART OF / PIÈCE DÉTACHÉE DE / RICAMBIO DI / PEÇA DE REPOSIÇÃO DE / ERSATZTEIL FÜR / ONDERDEEL VAN 2250300

341 00 93 Negro-Brillo / Black-Glossy / Noir-Brillant / Nero-Lucido / Preto-Brilho / Schwarz-Glänzend / Zwart-Glanzend \$ 840.00

RECAMBIO DE / SPARE PART OF / PIÈCE DÉTACHÉE DE / RICAMBIO DI / PEÇA DE REPOSIÇÃO DE / ERSATZTEIL FÜR / ONDERDEEL VAN 2499600

341 00 95 Negro-Mate / Black-Matte / Noir-Mat / Nero-Satinato / Preto-Mate / Schwarz-Matt / Zwart-Mat Verzilverd \$ 840.00

RECAMBIO DE / SPARE PART OF / PIÈCE DÉTACHÉE DE / RICAMBIO DI / PEÇA DE REPOSIÇÃO DE / ERSATZTEIL FÜR / ONDERDEEL VAN 2499800

CEPILLO ESCOBILLERO / TOILET BRUSH BRUSH / BROUSSE PORTE-BALAYETTE / SPAZZOLINO PORTASCOPINO / ESCOVA PARA PIAÇABA / TOILETTENBÜRSTENKOPF / BORSTEL WC-BORSTELHOUDER

350 11 00 Blanco / White / Blanc / Bianco / Branco / Weiss / Wit \$ 280.00

341 03 13 Negro / Black / Noir / Nero / Preto / Schwarz / Zwart \$ 280.00

RECAMBIO DE / SPARE PART OF / PIÈCE DÉTACHÉE DE / RICAMBIO DI / PEÇA DE REPOSIÇÃO DE / ERSATZTEIL FÜR / ONDERDEEL VAN 2250200, 2250300, 2499600, 2499800

TACO PLADUR / DRYWALL ANCHOR / CHEVILLE PLACOPLÂTRE / TASSELLO CARTONGESSO / TACO PLADUR / DÜBEL FÜR RIGIPS-PLATTEN / GIPSPLAAT PLUG

341 06 36 \$ 150.00

RECAMBIO DE / SPARE PART OF / PIÈCE DÉTACHÉE DE / RICAMBIO DI / PEÇA DE REPOSIÇÃO DE / ERSATZTEIL FÜR / ONDERDEEL VAN 2250221, 2250232, 2250246, 2250258, 2250259, 2250261, 2250264, 2250271, 2250321, 2250332, 2250346, 2250358, 2250359, 2250361, 2250365

PULSADOR + BOMBA DOSIFICADOR / DISPENSER PUSH BUTTON + PUMP /





Piezas que recogen
los **usos** y **formas**
básicas del baño para crear
ambientes **confortables**
y **cómodos**.

*Pieces that bring together
the **functions** and basic
forms of the bathroom
to create **comfortable**
and **pleasant** ambiences.*

DESIGN BY **COSMIC STUDIO**

logic



logic

Codificación / Code /
Codification / Codice / Codificação /
Kodifizierung / Codificatie

226 AA 21

COLECCIÓN / COLLECTION / COLLECTION /
COLLEZIONE / COLEÇÃO / KOLLEKTION / COLLECTIE

ACABADOS / FINISHES / FINITIONS / FINITURE / ACABAMENTOS /
OBERFLÄCHEN / AFWERKINGEN

MODELO / TYPE / MODÈLE / MODEL / MODELO / MODELL / MODEL

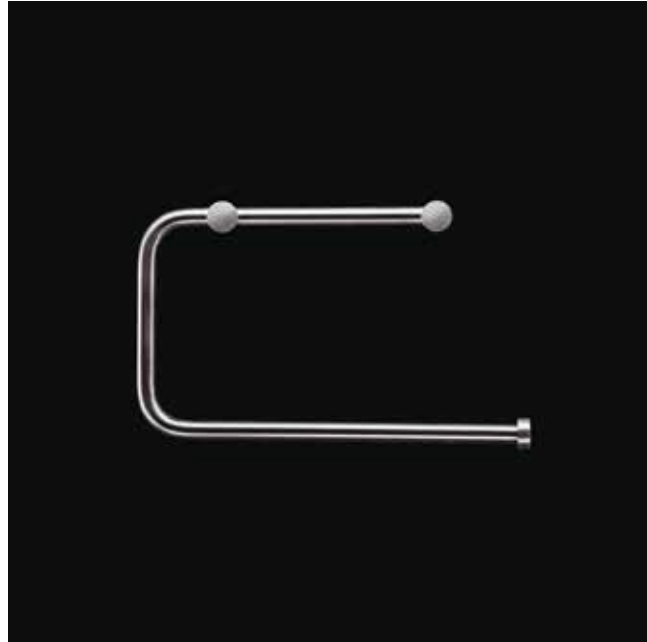

Características

Fácil instalación: tornillo de doble paso.
Fijaciones ocultas. Anticorrosión.

Features

Easy installation: double pitch screw.
Hidden attachments. Anti-corrosion.

Caractéristiques :

Facile installation : vis à double pas.
Fixations occultes. Anti-corrosion.

Caratteristiche:

Facile installazione : vite a doppio passo.
Fissaggio nascosto. Anticorrosivo.

Características:

Fácil instalação: parafuso de dupla
passagem. Fixações ocultas. Anti-corrosão.

Eigenschaften:

Einfache montage: doppel-pass-schraube.
Unsichtbare Befestigungen. Korrosionsschutz.

Kenmerken:

Eenvoudig te monteren: schroef met
dubbele draad. Verborgen bevestigingen.
Corrosiewerend.

Acabados

Finishes

Finitions

Finiture

Acabamentos

Oberflächen

Afwerkingen



02

Brillo
Bright
Brillant
Lucido
Brilho
Glänzend
Glanzend



03

Mate
Matte
Mat
Satinato
Mate
MattMat

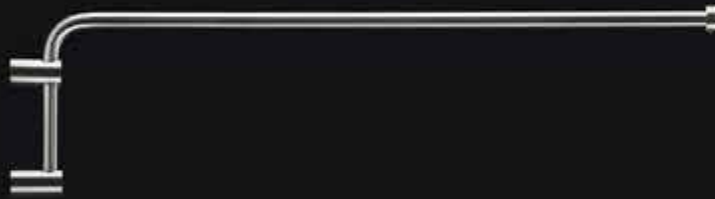

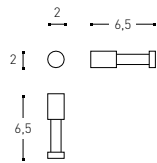

INCH 0.8x2.5x0.8

○ COLGADOR
HANGER
PATERE
APPENDINO
CABIDE
HAKEN
KLEERHAAK
226 AA 21
\$ 370.00

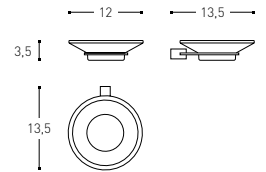

INCH 4.7x5.3x1.4

◇ JABONERA
SOAP DISH
PORTE-SAVON
PORTASAPONE
SABONETEIRA
SEIFENSCHALE
ZEEPBAKJE
226 AA 32
\$ 970.00

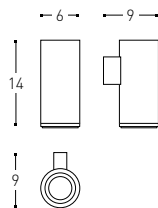

INCH 2.4x3.5x5.5

○△ PORTACEPILLOS
BRUSH-HOLDER
PORTE-BROSSE À DENTS
PORTASPAZZOLINI
PORTA-ESCOVA DE DENTES
ZAHBÜRSTENHALTER
TANDENBORSTELHOUDER
226 AA 03
\$ 1,370.00

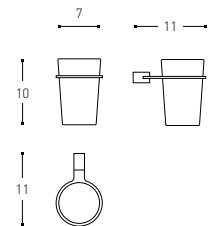

INCH 2.7x4.3x3.9

◇ PORTAVASO
GLASS HOLDER
PORTE-VERRE
PORTABICCHIERE
PORTA-COPO
ZAHNPUTZBECHER
BEKERHOUDER
226 AA 52
\$ 970.00

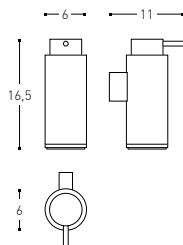

INCH 2.4x4.3x6.5

○△ DOSIFICADOR
SOAP DISPENSER
PORTE-SAVON LIQUIDE
DISPENSER
DISPENSADOR SABONETE
SEIFENSPENDER
DOSEERDER
226 AA 04
\$ 1,370.00

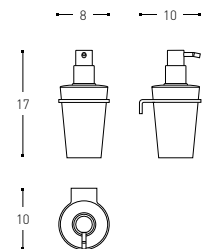

INCH 3.1x3.9x6.7

○△ DOSIFICADOR
SOAP DISPENSER
PORTE-SAVON LIQUIDE
DISPENSER
DISPENSADOR SABONETE
SEIFENSPENDER
DOSEERDER
226 AA 05
\$ 1,300.00



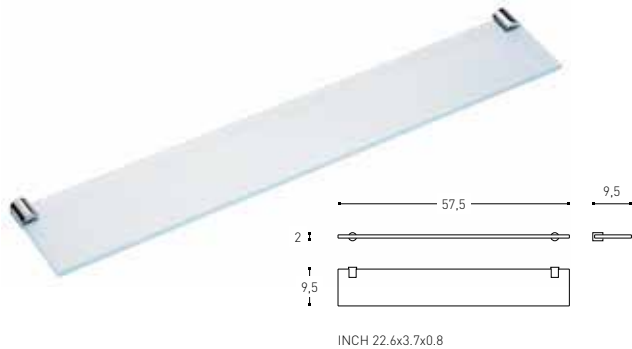

◊ Estante Vidrio
Glass Flat Shelf
Tablette Verre
Mensola Vetro
Prateleira Vidro
Glásablage
Glazen Rek
226 AA 45
\$ 1,530.00

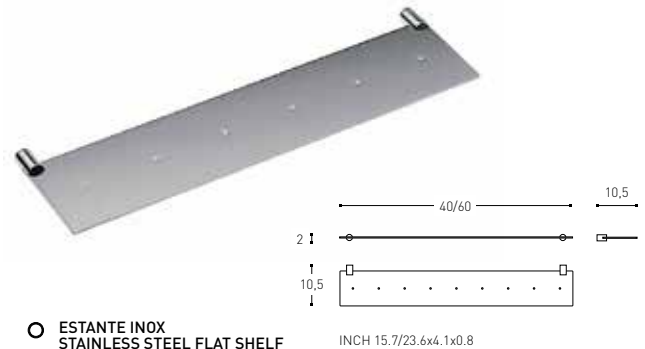

○ Estante Inox
Stainless Steel Flat Shelf
Tablette Inox
Mensola Inox
Prateleira Inox
Edelstahlablage
Roetvrij Staal Rek
226 AA 46 40 CM / INCH 15.7
\$ 1,600.00
226 AA 47 60 CM / INCH 23.6
\$ 1,900.00

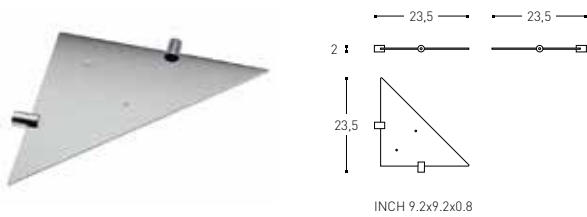

○ Estante Rincón Inox
Stainless Steel Corner Flat Shelf
Tablette Angle Inox
Mensola Angolo Inox
Prateleira de Canto Inox
Edelstahl Eckablage
Roetvrij Staal Rek
226 AA 43
\$ 1,600.00

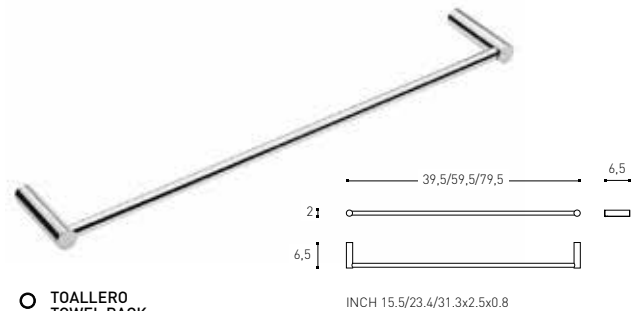

○ Toallero
Towel Rack
Porte-Serviette
Portasalviette
Toalheiro
Handtuchstange
Handdoekhouder
226 AA 64 41 CM / INCH 16.1 \$ 1,280.00
226 AA 65 60 CM / INCH 23.6 \$ 1,330.00
226 AA 66 80 CM / INCH 31.5 \$ 1,400.00

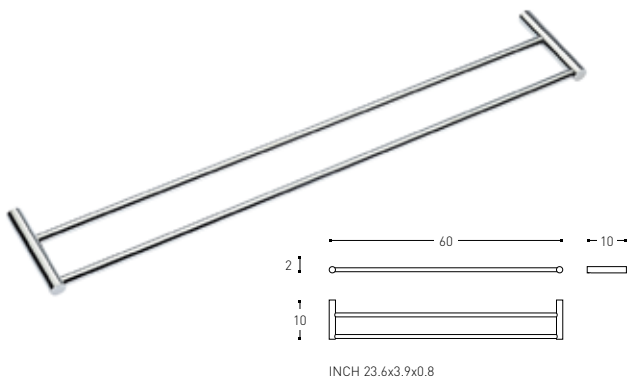

○ Toallero Doble
Double Towel Rack
Porte-Serviette Double
Portasalviette Doppio
Toalheiro Duplo
Doppelte Handtuchstange
Dubbele Handdoekhouder
226 AA 61
\$ 2,150.00

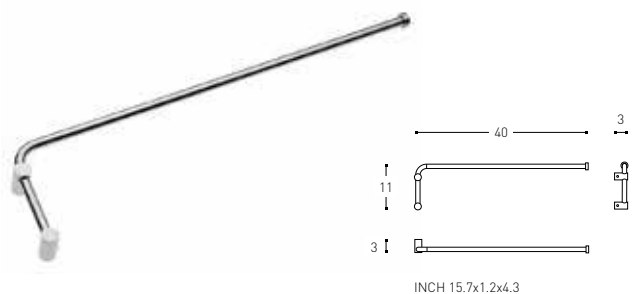

○ Toallero Giratorio
Swivel Towel Rack
Porte-Serviette Pivotant
Portasalviette a Snodo
Toalheiro Giratório
Handtuchhalter Schwenkbar
Handdoekhouder Draaibaar
226 AA 74
\$ 1,490.00

logic

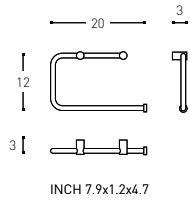

INCH 7.9x1.2x4.7

- TOALLERO ARO
TOWEL RING
PORTE-SERVIETTE ANNEAU
PORTASALVIETTE ANELLO
TOALHEIRO ARGOLA
HANDTUCHRING
HANDDOEKRING

226 AA 72
\$ 1,190.00

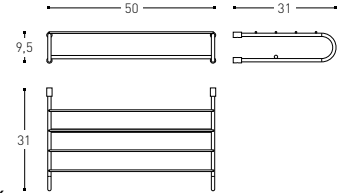
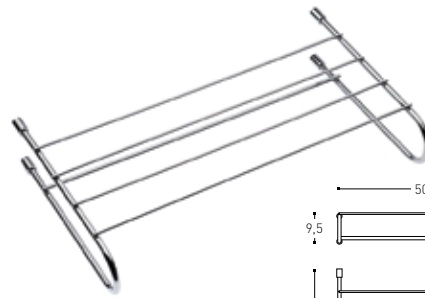

INCH 19.7x12.2x3.7

- TOALLERO ESTANTE
BRACKET SHELF TOWEL RACK
PORTE-LINGE DE BAIN
PORTASALVIETTE MENSOLA
TOALHEIRO PRATELEIRA
HANDTUCHABLAGE
HANDDOEKREK

226 AA 68
\$ 3,990.00

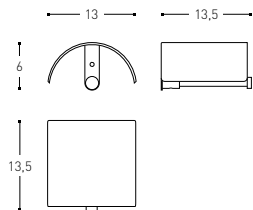

INCH 5.1x5.3x2.4

- PORTAPAPEL CON TAPA
PAPER HOLDER WITH COVER
PORTE-ROULEAUX COUVERT
PORTAROTOLO CON COPERCHIO
PORTA-ROLO COM TAMPA
ROLLENHALTER MIT DECKEL
TOILETROLHOUDER MET KLEP

226 AA 59
\$ 970.00

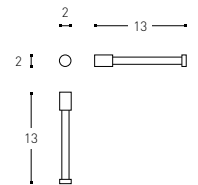

INCH 0.8x5.1x0.8

- PORTAPAPEL SIN TAPA
PAPER HOLDER WITHOUT COVER
PORTE-ROULEAUX SANS COUVERCLE
PORTAROTOLO SENZA COPERCHIO
PORTA-ROLO SEM TAMPA
ROLLENHALTER OHNE DECKEL
TOILETROLHOUDER ZONDER KLEP

226 AA 58
\$ 650.00

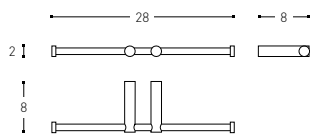

INCH 11x3.1x0.8

- PORTAPAPEL DOBLE SIN TAPA
DOUBLE PAPER HOLDER WITHOUT COVER
PORTE-ROULEAUX DOUBLE SANS COUVERCLE
PORTAROTOLO DOPPIO SENZA COPERCHIO
PORTA-ROLO DUPLO SEM TAMPA
DOPPELTER RÖLLENHALTER OHNE DECKEL
DUBBELE TOILETROLHOUDER ZONDER KLEPP

226 AA 57
\$ 1,370.00

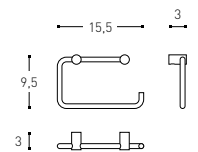

INCH 6.1x1.2x3.7

- PORTAPAPEL / TOALLERO
PAPER HOLDER / TOWEL RACK
PORTE-ROULEAUX / PORTE-SERVIETTE
PORTAROTOLO / PORTASALVIETTE
PORTA-ROLO / TOALHEIRO
ROLLENHALTER / HANDTUCHSTANGE
TOILETROLHOUDER / HANDDOEKREK

226 AA 54
\$ 1,160.00

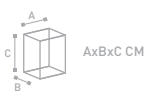

AxBxC CM

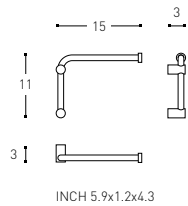

- PORTAPAPEL / TOALLERO GIRATORIO
- PAPER HOLDER / SWIVEL TOWEL RACK
- PORTE-ROULEAUX / PORTE-SERVIETTE PIVOTANT
- PORTAROTOLO / PORTASALVIETTE A SNODO
- PORTA-ROLO / TOALHEIRO GIRATÓRIO
- RÖLLENHALTER / HANDTUCHSTANGE SCHWENKBAR
- TOILETROLHOUDER / HANDDOEKHOUDER DRAAIBAAR

226 AA 73
\$ 1,370.00

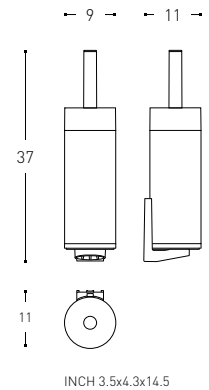

- △ ESCOBILLERO SUELO / PARED
- TOILET BRUSH FLOOR / WALL
- PORTE BALAYETTE SOL / MUR
- PORTASCOPIANO A TERRA / MURO
- PORTA-PIACABA SOLO / PAREDE
- TOILETTENBÜRSTENHALTER BODEN / WAND
- WC-BORSTELHOUDER VLOER / MUUR

249 98 00 NEGRO-MATE / BLACK-MATTE
\$ 1,620.00

249 96 00 NEGRO-BRILLO / BLACK-GLOSSY
\$ 1,620.00

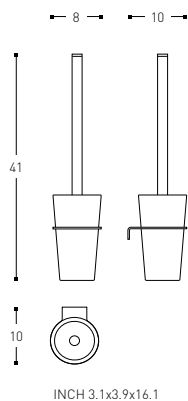

- ◇ ESCOBILLERO
- TOILET BRUSH
- PORTE-BALAYETTE
- PORTASCOPIANO
- PORTA-PIACABA
- TOILETTENBÜRSTENHALTER
- WC-BORSTELHOUDER

226 AA 00
\$ 1,400.00

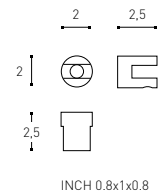

- JUEGO 2 SOPORTES ESTANTE
- SET OF 2 FLAT SHELF SUPPORTS
- JEU DE 2 SUPPORTS TABLETTE
- COPPIA 2 SUPPORTI MENSOLA
- CONJUNTO 2 SUPORTES PRATELEIRA
- 2 ABLAGEBEFESTIGUNGEN
- STEL 2 REKHOUDERS

226 AA 80
\$ 630.00

logic

recambios spare parts pièces détachées ricambi peças de reposição ersatzteile reserveonderdelen

ACCESORIO SUJECIÓN PARED (1 TORNILLO) / WALL MOUNTING SET (1 SCREW) / KIT FIXATION MURALE (1 VIS) / ACCESSORIO FISSAGGIO MURO (1 VITE) / CONJUNTO FIXAÇÃO PAREDE (1 PARAFUSO) / WANDFIXIERUNGSSET (1 SCHRAUBE) / MONTAGESSET WAND (1 SCHROEF)

330 86 00 \$ 140.00

RECAMBIO DE / SPARE PART OF / PIÈCE DÉTACHÉE DE / RICAMBIO DI / PEÇA DE REPOSIÇÃO DE / ERSATZTEIL FÜR / ONDERDEEL VAN
2260254, 2260257, 2260261, 2260264, 2260265, 2260266, 2260272, 2260273, 2260274, 2260354, 2260357, 2260361, 2260364, 2260365, 2260366

ACCESORIO SUJECIÓN PARED / WALL MOUNTING SET / KIT FIXATION MURALE / ACCESSORIO FISSAGGIO MURO / CONJUNTO FIXAÇÃO PAREDE / WANDFIXIERUNGSSET / MONTAGESSET WAND

341 00 44 Brillo / Glossy / Brillant / Lucido / Brihho / Glänzend / Glanzend \$ 540.00

RECAMBIO DE / SPARE PART OF / PIÈCE DÉTACHÉE DE / RICAMBIO DI / PEÇA DE REPOSIÇÃO DE / ERSATZTEIL FÜR / ONDERDEEL VAN
2260268

341 00 45 Mate / Matte / Mat / Satinato / Mate / Matt / Mat \$ 540.00

RECAMBIO DE / SPARE PART OF / PIÈCE DÉTACHÉE DE / RICAMBIO DI / PEÇA DE REPOSIÇÃO DE / ERSATZTEIL FÜR / ONDERDEEL VAN
2260368

ACCESORIO SUJECIÓN BÁSICO / BASIC MOUNTING SET / KIT FIXATION DE BASE / ACCESSORIO FISSAGGIO BASE / CONJUNTO FIXAÇÃO BASICO / STANDARD FIXIERUNGSSET / MONTAGESSET FUNDAMENTEEL

341 00 18 \$ 120.00

RECAMBIO DE / SPARE PART OF / PIÈCE DÉTACHÉE DE / RICAMBIO DI / PEÇA DE REPOSIÇÃO DE / ERSATZTEIL FÜR / ONDERDEEL VAN
2260200, 2260203, 2260204, 2260205, 2260245, 2260280, 2260300, 2260304, 2260305, 2260345, 2260380

ACCESORIO SUJECIÓN PARED REDONDO / ROUND WALL MOUNTING SET / KIT FIXATION MURALE ROND / ACCESSORIO FISSAGGIO MURO ROTONDO / CONJUNTO SUPORTE PAREDE REDONDO / WANDFIXIERUNGSSET RUND / MONTAGESSET WAND ROND

330 76 00 \$ 140.00

RECAMBIO DE / SPARE PART OF / PIÈCE DÉTACHÉE DE / RICAMBIO DI / PEÇA DE REPOSIÇÃO DE / ERSATZTEIL FÜR / ONDERDEEL VAN
2260224, 2260324

JUEGO BIS SUJECIÓN (M5/M6) / SCREW MOUNTING SET (M5/M6) / SET VIS FIXATION (M5/M6) / KIT VITE FISSAGGIO (M5/M6) / CONJUNTO BIS FIXAÇÃO (M5/M6) / MADENSCHRAUBENSSET (M5/M6) / MONTAGESSET (M5/M6)

330 91 00 \$ 60.00

JABONERA / SOAP DISH / PORTE-SAVON / PORTASAPONE / SABONETEIRA / SEIFENSCHALE / ZEEPBAKJE

330 60 00 Mate / Matte / Mat / Satinato / Mate / Matt / Mat \$ 460.00

RECAMBIO DE / SPARE PART OF / PIÈCE DÉTACHÉE DE / RICAMBIO DI / PEÇA DE REPOSIÇÃO DE / ERSATZTEIL FÜR / ONDERDEEL VAN
2260232, 2260332

VASO / GLASS / VERRE / BICCHIERE / COPO / ZAHNPUTZBECHER / BEKER

330 27 31 Mate / Matte / Mat / Satinato / Mate / Matt / Mat \$ 300.00

RECAMBIO DE / SPARE PART OF / PIÈCE DÉTACHÉE DE / RICAMBIO DI / PEÇA DE REPOSIÇÃO DE / ERSATZTEIL FÜR / ONDERDEEL VAN
2260252, 2260352

PULSADOR + BOMBA DOSIFICADOR / DISPENSER PUSH BUTTON + PUMP / POUSSOIR + POMPE PORTE-SAVON LIQUIDE / PULSANTE + POMPETTA DISPENSER / BOTÃO + BOMBA DOSEADOR / PUMPENKOPF FÜR SEIFENSPENDER / DRUKKNOP + POMP VERDELER VLOEIBARE ZEEP

340 13 03 Mate / Matte / Mat / Satinato / Mate / Matt / Mat \$ 440.00

RECAMBIO DE / SPARE PART OF / PIÈCE DÉTACHÉE DE / RICAMBIO DI / PEÇA DE REPOSIÇÃO DE / ERSATZTEIL FÜR / ONDERDEEL VAN
2260305

341 01 13 Negro brillo / Glossy black / Noir brillant / Nero lucido / Preto brilho / Schwarz glänzend / Glanzend zwart \$ 650.00

RECAMBIO DE / SPARE PART OF / PIÈCE DÉTACHÉE DE / RICAMBIO DI / PEÇA DE REPOSIÇÃO DE / ERSATZTEIL FÜR / ONDERDEEL VAN
2260204

341 01 15 Negro mate / Matte black / Noir mat / Nero opaco / Preto mate / Schwarz matt / Mat zwart \$ 650.00

RECAMBIO DE / SPARE PART OF / PIÈCE DÉTACHÉE DE / RICAMBIO DI / PEÇA DE REPOSIÇÃO DE / ERSATZTEIL FÜR / ONDERDEEL VAN
2260304

BOMBA DOSIFICADOR / DISPENSER PUMP / POMPE PORTE-SAVON LIQUIDE / POMPETTA DISPENSER / BOMBA DISPENSADOR / DOSIERPUMPE SEIFENSPENDER / DOSEERPOMPE

341 06 22 \$ 140.00

RECAMBIO DE / SPARE PART OF / PIÈCE DÉTACHÉE DE / RICAMBIO DI / PEÇA DE REPOSIÇÃO DE / ERSATZTEIL FÜR / ONDERDEEL VAN
2260204, 2260304

FRASCO DOSIFICADOR / SOAP DISPENSER FLASK / FLACON PORTE-SAVON / FLACONE DISPENSER / FRASCO DISPENSADOR / FLAKON SEIFENSPENDER / DOSEERFLACON

330 85 00 Mate / Matte / Mat / Satinato / Mate / Matt / Mat \$ 590.00

RECAMBIO DE / SPARE PART OF / PIÈCE DÉTACHÉE DE / RICAMBIO DI / PEÇA DE REPOSIÇÃO DE / ERSATZTEIL FÜR / ONDERDEEL VAN
2260205, 2260305

ESTANTE / SHELF / TABLETTE / MENSOLA / PRATELEIRA / ABLAGE / REK 57,5 CM / INCH 22.6

330 31 30 Mate / Matte / Mat / Satinato / Mate / Matt / Mat \$ 1,350.00

RECAMBIO DE / SPARE PART OF / PIÈCE DÉTACHÉE DE / RICAMBIO DI / PEÇA DE REPOSIÇÃO DE / ERSATZTEIL FÜR / ONDERDEEL VAN
2260245, 2260345

VASO ESCOBILLERO / TOILET BRUSH GLASS / VERRE PORTE-BALAYETTE / BICCHIERE PORTASCOPINO / COPO PORTA-PIAÇABA / GLAS TOILETTENBÜRSTENHALTER / WC-BORSTELHOUDERPOT

330 57 00 Mate / Matte / Mat / Satinato / Mate / Matt / Mat \$ 370.00

RECAMBIO DE / SPARE PART OF / PIÈCE DÉTACHÉE DE / RICAMBIO DI / PEÇA DE REPOSIÇÃO DE / ERSATZTEIL FÜR / ONDERDEEL VAN
2260200, 2260300

PALO ESCOBILLERO CON CEPILLO / TOILET BRUSH STICK WITH BRUSH / MANCHE BALAYETTE AVEC BROUSSE / MANICO SCOPINO CON SPAZZOLINO / ESCOVA COM CABO PORTA-PIAÇABA / TOILETTENBÜRSTE MIT GRIFF / HANDVAT MET BORSTEL

341 00 95 Negro mate / Matte black / Noir mat / Nero opaco / Preto mate / Schwarz matt / Mat zwart \$ 840.00

RECAMBIO DE / SPARE PART OF / PIÈCE DÉTACHÉE DE / RICAMBIO DI / PEÇA DE REPOSIÇÃO DE / ERSATZTEIL FÜR / ONDERDEEL VAN
2499800

341 00 93 Negro brillo / Glossy black / Noir brillant / Nero lucido / Preto brilho / Schwarz glänzend / Glanzend zwart \$ 840.00

RECAMBIO DE / SPARE PART OF / PIÈCE DÉTACHÉE DE / RICAMBIO DI / PEÇA DE REPOSIÇÃO DE / ERSATZTEIL FÜR / ONDERDEEL VAN
2499600

341 00 61 Brillo / Glossy / Brillant / Lucido / Brihho / Glänzend / Glanzend \$ 700.00

RECAMBIO DE / SPARE PART OF / PIÈCE DÉTACHÉE DE / RICAMBIO DI / PEÇA DE REPOSIÇÃO DE / ERSATZTEIL FÜR / ONDERDEEL VAN
2260200

341 00 62 Mate / Matte / Mat / Satinato / Mate / Matt / Mat \$ 700.00

RECAMBIO DE / SPARE PART OF / PIÈCE DÉTACHÉE DE / RICAMBIO DI / PEÇA DE REPOSIÇÃO DE / ERSATZTEIL FÜR / ONDERDEEL VAN
2260300

CEPILLO ESCOBILLERO / TOILET BRUSH BRUSH / BRASSE PORTE-BALAYETTE / SPAZZOLINO PORTASCOPINO / ESCOVA PARA PIAÇABA / TOILETTENBÜRSTENKOPF / BORSTEL WC-BORSTELHOUDER

350 11 00	Blanco / White / Blanc / Bianco / Branco / Weiss / Wit	\$ 280.00
341 03 13	Negro / Black / Noir / Nero / Preto / Schwarz / Zwart	\$ 280.00

RECAMBIO DE / SPARE PART OF / PIÈCE DÉTACHÉE DE / RICAMBIO DI / PEÇA DE REPOSIÇÃO DE / ERSATZTEIL FÜR / ONDERDEEL VAN
2260200, 2260300, 2499600, 2499800

TACO PLADUR / DRYWALL ANCHOR / CHEVILLE PLACOPLÂTRE / TASSELLO CARTONGESSO / TACO PLADUR / DÜBEL FÜR RIGIPS-PLATTEN / GIPSPLAAT PLUG

341 06 36 **\$ 150.00**

RECAMBIO DE / SPARE PART OF / PIÈCE DÉTACHÉE DE / RICAMBIO DI / PEÇA DE REPOSIÇÃO DE / ERSATZTEIL FÜR / ONDERDEEL VAN
2260200, 2260203, 2260204, 2260205, 2260221, 2260232, 2260243, 2260245, 2260246, 2260247, 2260252, 2260254, 2260257, 2260258, 2260259, 2260261, 2260264, 2260265, 2260266, 2260268, 2260272, 2260273, 2260274, 2260300, 2260303, 2260304, 2260305, 2260321, 2260332, 2260343, 2260345, 2260346, 2260347, 2260352, 2260354, 2260357, 2260358, 2260359, 2260361, 2260364, 2260365, 2260366, 2260368, 2260372, 2260373, 2260374



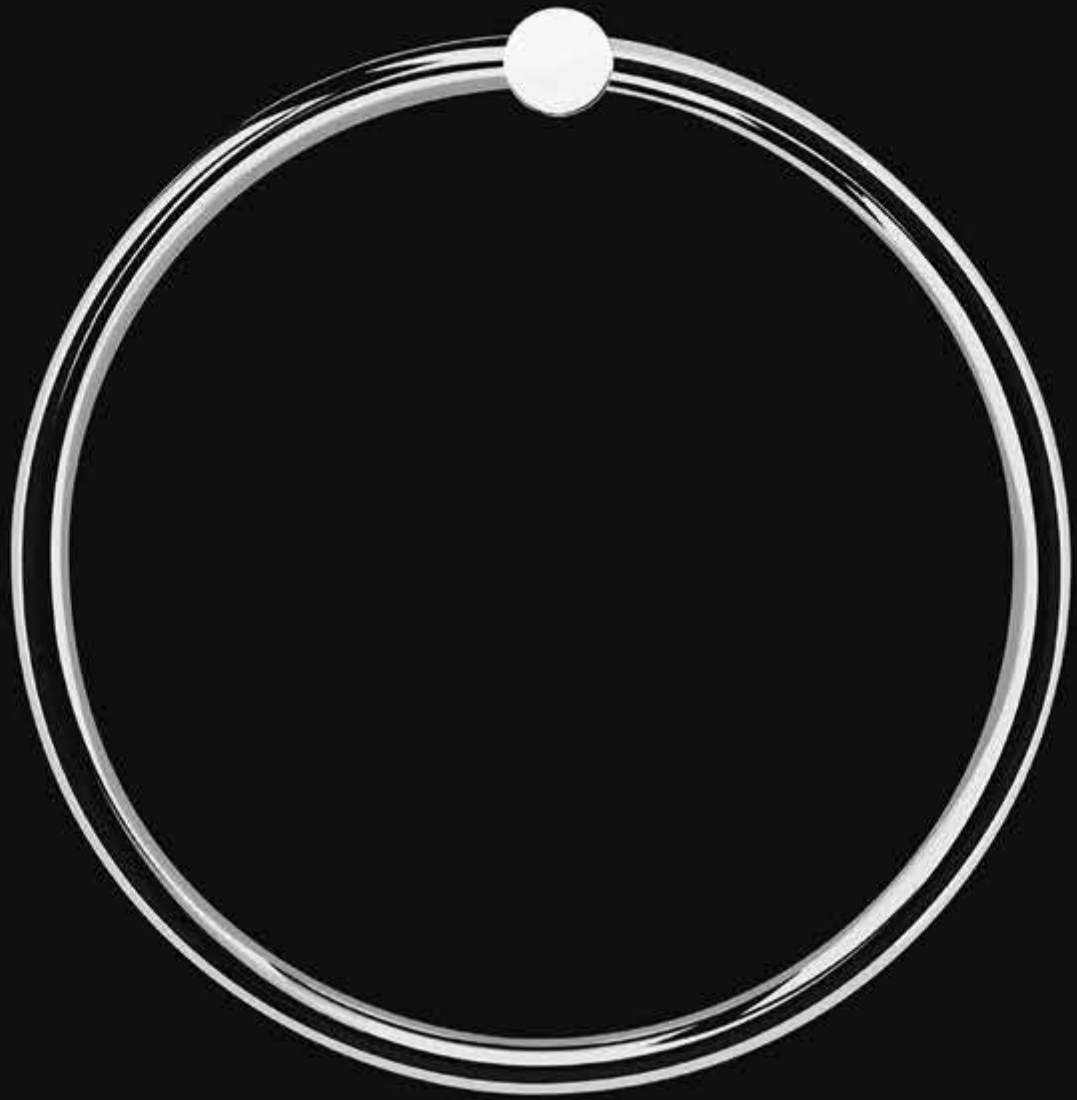

El máximo **bienestar**
en el entorno del **baño**
con **mínimos** elementos.

*Maximum wellbeing in
the **bathroom** environment
with **minimum** elements.*



mini malism

DESIGN BY COSMIC STUDIO

minimalism



Características

Fácil instalación: tornillo de doble paso.
Fijaciones ocultas. Anticorrosión.

Features

*Easy installation: double pitch screw.
Hidden attachments. Anti-corrosion.*

Caractéristiques :

Facile installation : vis à double pas.
Fixations occultes. Anti-corrosion.

Caratteristiche:

*Facile installazione : vite a doppio passo.
Fissaggio nascosto. Anticorrosivo.*

Características:

Fácil instalação: parafuso de dupla
passagem. Fixações ocultas.
Anti-corrosão.

Eigenschaften:

*Einfache montage: doppel-pass-
schraube. Unsichtbare Befestigungen.
Korrosionsschutz.*

Kenmerken:

Eenvoudig te monteren: schroef met
dubbele draad. Verborgene bevestigingen.
Corrosiewerend.

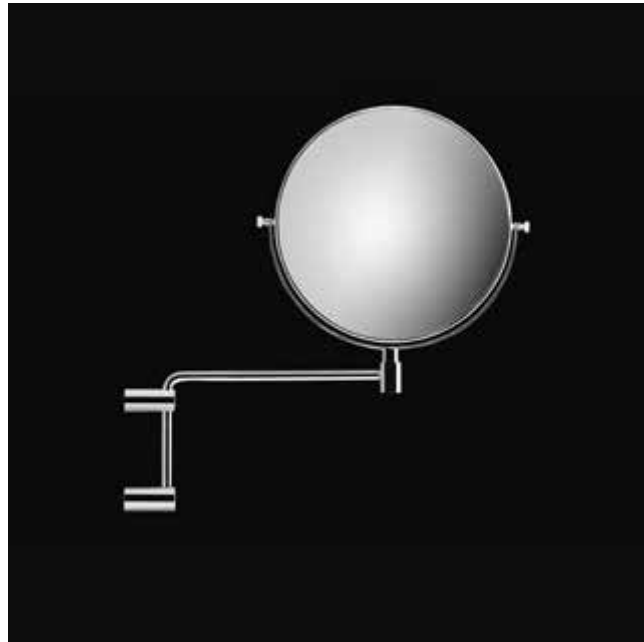

Acabados
Finishes
Finitions
Finiture
Acabamentos
Oberflächen
Afwerkingen



Cromo
Chrome
Chromé
Cromo
Cromo
Chrom
Verchromd

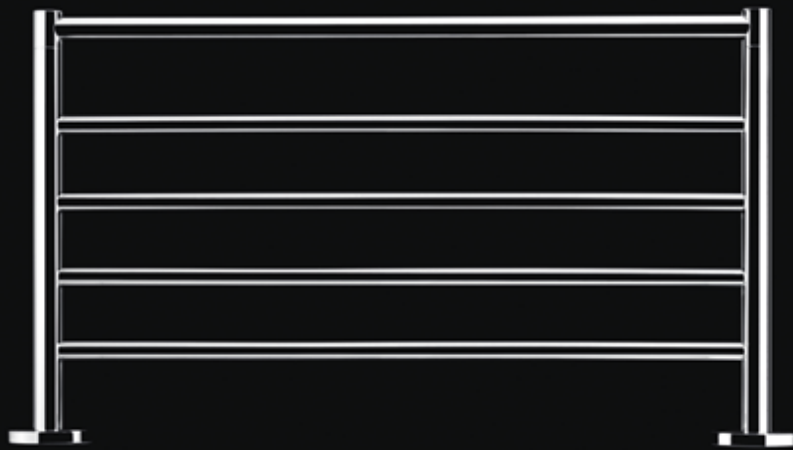

minimalism

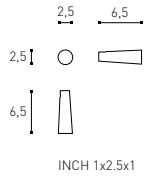

- COLGADOR
HANGER
PATÈRE
APPENDINO
CABIDE
HAKEN
KLEERHAAK

MX 240 01 21
\$ 560.00

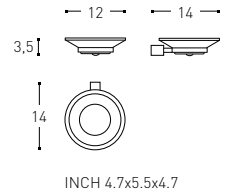

- ◆ JABONERA
SOAP DISH
PORTE-SAVON
PORTASAPONE
SABONETEIRA
SEIFENSCHALE
ZEEPBKJJE

MX 240 01 32
\$ 1,350.00

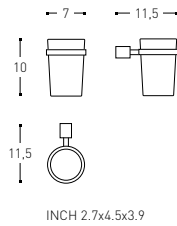

- ◆ PORTAVASO
GLASS HOLDER
PORTE - VERRE
PORTABICCHIERE
PORTA - COPO
ZAHNPUTZBECHER
BEKERHOUDER

240 01 52
\$ 1,280.00

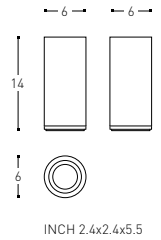

- △ PORTACEPILLOS ENCIMERA
FREE STANDING BRUSH-HOLDER
PORTE-BROSSE À DENT SUR PLAN
PORTASPAZZOLINI SOPRA PIANO
PORTA-ESCOVA BANCADA
AUFLAGEZAHNBÜRSTENHALTER
TANDENBORSTEKHOUDER VOOR BLAD

251 01 53
\$ 1,460.00

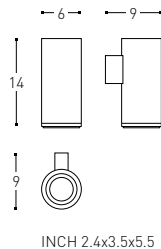

- △ PORTACEPILLOS
BRUSH-HOLDER
PORTE-BROSSE À DENT
PORTASPAZZOLINI
PORTA-ESCOVA
ZAHNBÜRSTENHALTER
TANDENBORSTEKHOUDER

MX 251 01 54
\$ 1,820.00

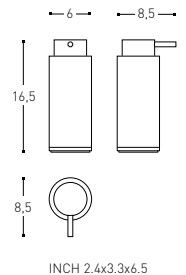

- △ DOSIFICADOR ENCIMERA
FREE STANDING SOAP DISPENSER
PORTE-SAVON LIQUIDE À POSER
DISPENSER DA APPOGGIO
DISPENSADOR SABONETE DE BAN-
CADA
AUFLAGESEIFENSPENDER
DOSEERDER VOOR BLAD

251 01 04
\$ 1,620.00

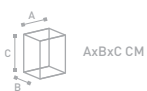

090

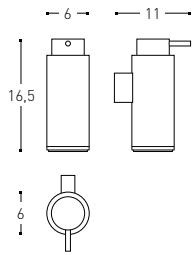

INCH 2.4x4.3x6.5

- ⊕ △ DOSIFICADOR SOAP DISPENSER PORTE-SAVON LIQUIDE DISPENSER DISPENSADOR SABONETE SEIFENSPENDER DOSEERDER
- 251 01 05**
- \$ 2,010.00**

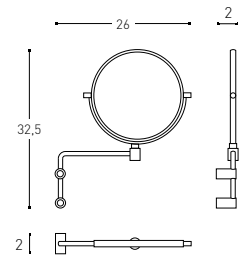

INCH 10.2x0.8x12.8

- ⊕ ◆ ESPEJO AUMENTO (x1) (x3) MAGNIFYING MIRROR (x1) (x3) MIROIR GROSSISSANT (x1) (x3) SPECCHIO AUMENTO (x1) (x3) ESPELHO AUMENTO (x1) (x3) VERGRÖSSERUNGSSPIEGEL (x1) (x3) VERGROOTSPIEGEL (x1) (x3)
- MX 240 01 86**
- \$ 2,190.00**

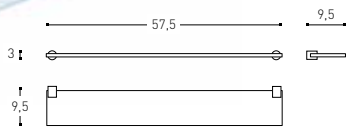
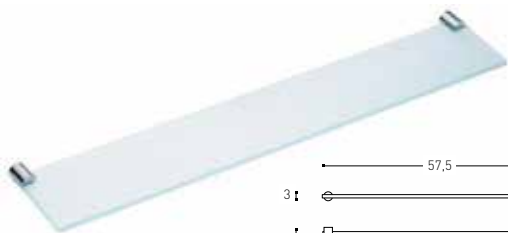

INCH 22.6x3.7x1.2

- ⊕ ◆ ESTANTE VIDRIO GLASS FLAT SHELF TABLETTE VERRE MENSOLA VETRO PRATELEIRA VIDRO GLASABLAGE GLAZEN REK
- 240 01 45**
- \$ 1,870.00**

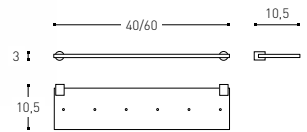

INCH 15.7/23.6x4.1x1.2

- ⊕ ○ ESTANTE INOX STAINLESS STEEL FLAT SHELF TABLETTE INOX MENSOLA INOX PRATELEIRA INOX EDELSTAHLABLAGE ROETVRIJ STAAL REK
- 240 01 46 40 CM / INCH 15.7**
- \$ 1,600.00**
- 240 01 47 60 CM / INCH 23.6**
- \$ 1,870.00**

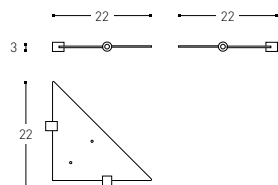

INCH 8.7x8.7x1.2

- ⊕ ○ ESTANTE RINCÓN INOX STAINLESS STEEL CORNER FLAT SHELF TABLETTE ANGOLO INOX MENSOLA ANGOLO INOX PRATELEIRA DE CANTO INOX EDELSTAHL ECKABLAGE ROETVRIJ STAAL REK HOEKVORM
- 240 01 43**
- \$ 1,600.00**

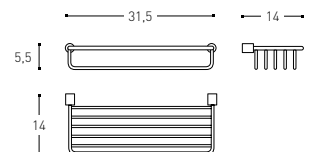

INCH 12.4x5.5x2.2

- ⊕ CONTAINER CONTAINER PANIER CESTINO CONTENITORE WANDKORB REKJE
- MX 240 01 49**
- \$ 1,510.00**

minimalism

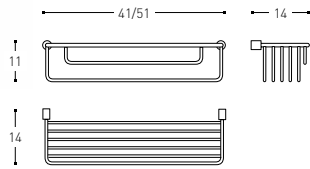

CONTAINER
CONTAINER
PANIER
CESTINO
CONTÊNER
WANDKORB
REKJE

INCH 16.1/20.1x5.5x4.3

MX 240 01 48 41 CM / INCH 16.1
\$ 1,870.00
240 01 88 51 CM / INCH 20.1
\$ 2,220.00

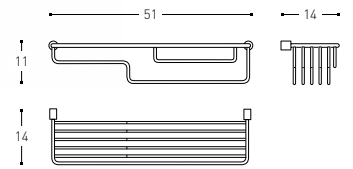

CONTAINER ESCALÓN
CONTAINER WITH STAGE
PANIER ÉCHELON
CESTINO SCALA
CONTÊNER ESCALÃO
WANDKORB MIT STUFE
REKJE TWEE NIVEAUS

INCH 20x5.5x4.3

MX 240 01 87
\$ 2,220.00

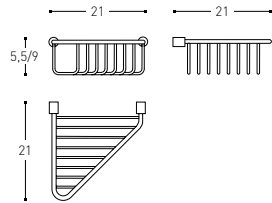

CONTAINER RINCÓN
CORNER CONTAINER
PANIER ANGLE
CESTINO ANGOLO
CONTÊNER DE CANTO
ECKWANKORB
REKJE HOEKVORM

INCH 8.3x8.3x2.2/3.5

240 01 50 5,5 CM / INCH 2.2
\$ 1,510.00
240 01 89 9 CM / INCH 3.5
\$ 1,850.00

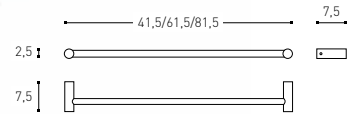

TOALLERO
TOWEL RACK
PORTE - SERVIETTE
PORTASALVIETTE
TOALHEIRO
HANDTUCHSTANGE
HANDDOEKHOUDER

INCH 16.3/24.2/32.1x2.9x1

MX 240 01 64 41,5 CM / INCH 16.3
\$ 1,600.00
MX 240 01 65 61,5 CM / INCH 24.2
\$ 1,740.00

240 01 66 81,5 CM / INCH 32.1
\$ 1,790.00

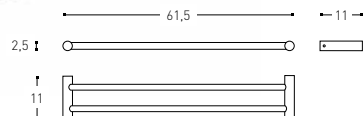

INCH 24.2x4.3x1

TOALLERO DOBLE
DOUBLE TOWEL RACK
PORTE-SERVIETTE DOUBLE
PORTASALVIETTE DOPPIO
TOALHEIRO DUPLO
DOPPELTE HANDTUCHSTANGE
DUBBELE HANDDOEKHOUDER

240 01 61
\$ 2,420.00

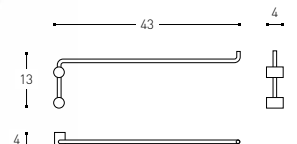

INCH 16.9x1.6x5.1

TOALLERO GIRATORIO
SWIVEL TOWEL RACK
PORTE - SERVIETTE PIVOTANT
PORTASALVIETTE A SNODO
TOALHEIRO GIRATÓRIO
HANDTUCHSTANGE SCHWENKBAR
HANDDOEKHOUDER DRAAIBAAR

240 01 74
\$ 1,530.00



AxBxC CM

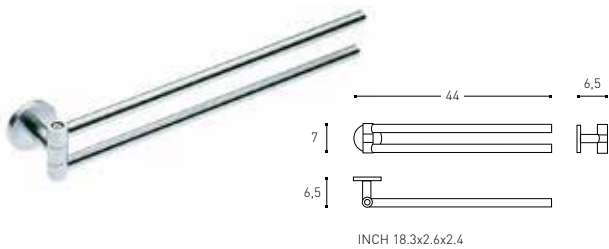

- TOALLERO GIRATORIO DOBLE
- DOUBLE SWIVEL TOWEL RACK
- PORTE-SERVLETTE PIVOTANT DOUBLE
- PORTASALVIETTE A SNODO DOPPIO
- TOALHEIRO GIRATÓRIO DUPLLO
- DOPPELTER HANDTUCHHALTER SCHWENKBAR
- DUBBELE HANDDOEKHOUDER DRAAIBAAR

MX 240 01 75
\$ 2,580.00

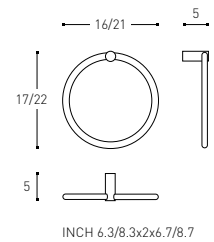

- TOALLERO ARO
- TOWEL RING
- PORTE - SERVIETTE ANNEAU
- PORTASALVIETTE ANELLO
- TOALHEIRO ARGOLA
- HANDTUCHRING
- HANDDOEKRING

MX 240 01 71 16x5x17 CM / INCH 6.3x2x6.7
\$ 1,190.00

240 01 72 21x5x22 CM / INCH 8.3x2x8.7
\$ 1,280.00

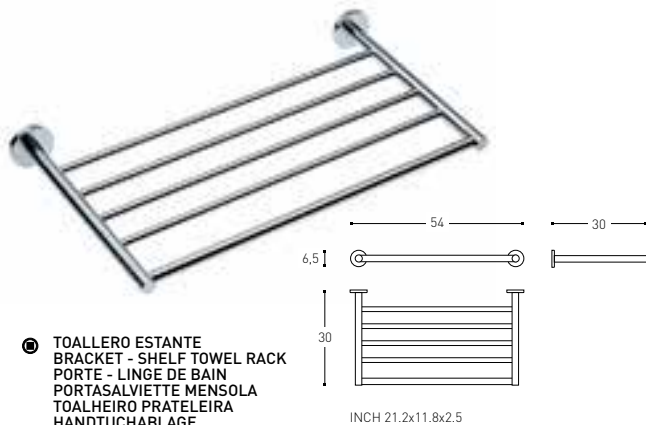

- TOALLERO ESTANTE
- BRACKET - SHELF TOWEL RACK
- PORTE - LINGE DE BAIN
- PORTASALVIETTE MENSOLA
- TOALHEIRO PRATELEIRA
- HANDTUCHABLAGE
- HANDDOEKREK

240 01 68
\$ 4,470.00

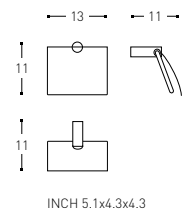

- PORTAPAPEL CON TAPA
- PAPER HOLDER WITH COVER
- PORTE - ROULEAUX COUVERT
- PORTAROTOLO CON COPERCHIO
- PORTA ROLO COM TAMPA
- ROLLENHALTER MIT DECKEL
- TOILETROLHOUDER MET KLEP

MX 240 01 59
\$ 1,350.00



- PORTAPAPEL SIN TAPA
- PAPER HOLDER WITHOUT COVER
- PORTE - ROULEAUX SANS COUVERCLE
- PORTAROTOLO SENZA COPERCHIO
- PORTA - ROLO SEM TAMPA
- ROLLENHALTER OHNE DECKEL
- TOILETROLHOUDER ZONDER KLEP

MX 240 01 58
\$ 880.00

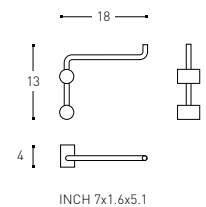

- PORTAPAPEL / TOALLERO GIRATORIO
- PAPER HOLDER / SWIVEL TOWEL RACK
- PORTE - ROULEAUX / PORTE - SERVIETTE PIVOTANT
- PORTAROTOLO / PORTASALVIETTE A SNODO
- PORTA - ROLO / TOALHEIRO GIRATÓRIO
- ROLLENHALTER / HANDTUCHSTANGE SCHWENKBAR
- TOILETROLHOUDER / HANDDOEKHOUDER DRAAIBAAR

240 01 73
\$ 1,350.00

minimalism



ESCOBILLERO
TOILET BRUSH
PORTE - BALAYETTE
PORTASCOPINO
PORTA - PIAÇABA
TOILETTENBÜRSTENHALTER
WC-BORSTELHOUDER

MX 240 01 00
\$ 2,130.00

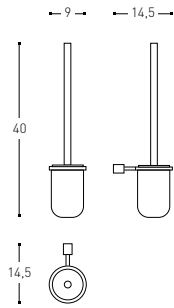

INCH 3.5x5.7x15.7



ESCOBILLERO SUELO/PARED
FLOOR/WALL TOILET BRUSH
PORTE-BALAYETTE SOL/MUR
PORTASCOPINO A TERRA/MURO
PORTA-PIACABA SOLO/PAREDE
TOILETTENBÜRSTENHALTER BODEN/WAND
WC-BORSTELHOUDER VLOER/WAND

251 01 00
\$ 2,720.00

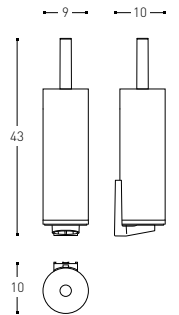

INCH 3.5x3.9x16.9

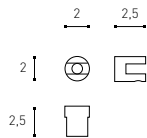

INCH 0.8x1x0.8

● JUEGO 2 SOPORTES ESTANTE
SET OF 2 FLAT SHELF SUPPORTS
JEU DE 2 SUPPORTS TABLETTE
COPPIA 2 SUPPORTI MENSOLA
CONJUNTO 2 SUPORTES PRATELEIRA
2 ABLAGEBEFESTIGUNGEN
STEL 2 REKHOUDERS

240 01 80
\$ 500.00

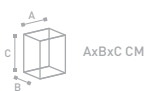

094

MX PRODUCTO DE STOCK EN MÉXICO

minimalism

recambios spare parts pièces détachées ricambi peças de reposição ersatzteile reserveonderdelen

ACCESORIO SUJECIÓN BÁSICO / BASIC MOUNTING SET / KIT FIXATION DE BASE / ACCESSORIO FISSAGGIO BASE / CONJUNTO FIXAÇÃO BASICO / STANDARD FIXIERUNGSSET / MONTAGESET FUNDAMENTEEL

341 00 18 \$ 120.00

RECAMBIO DE / SPARE PART OF / PIÈCE DÉTACHÉE DE / RICAMBIO DI / PEÇA DE REPOSIÇÃO DE / ERSATZTEIL FÜR / ONDERDEEL VAN 2400145, 2400180

ACCESORIO SUJECIÓN PARED REDONDO / ROUND WALL MOUNTING SET / KIT FIXATION MURALE ROND / ACCESSORIO FISSAGGIO MURO ROTONDO / CONJUNTO SUPORTE PAREDE REDONDO / WANDFIXIERUNGSSET RUND / MONTAGESET WAND ROND

330 76 00 \$ 140.00

RECAMBIO DE / SPARE PART OF / PIÈCE DÉTACHÉE DE / RICAMBIO DI / PEÇA DE REPOSIÇÃO DE / ERSATZTEIL FÜR / ONDERDEEL VAN 2400168

ACCESORIO SUJECIÓN PARED (1 TORNILLO) / WALL MOUNTING SET (1 SCREW) / KIT FIXATION MURALE (1 VIS) / ACCESSORIO FISSAGGIO MURO (1 VITE) / CONJUNTO FIXAÇÃO PAREDE (1 PARAFUSO) / WANDFIXIERUNGSSET (1 SCHRAUBE) / MONTAGESET WAND (1 SCHROEF)

330 86 00 \$ 140.00

RECAMBIO DE / SPARE PART OF / PIÈCE DÉTACHÉE DE / RICAMBIO DI / PEÇA DE REPOSIÇÃO DE / ERSATZTEIL FÜR / ONDERDEEL VAN 2400121, 2400171, 2400172, 2400186, 2400158, 2400164, 2400165, 2400166, 2400173

ACCESORIO SUJECIÓN PARED / WALL MOUNTING SET / KIT FIXATION MURALE / ACCESSORIO FISSAGGIO MURO / CONJUNTO FIXAÇÃO PAREDE / WANDFIXIERUNGSSET / MONTAGESET WAND

341 00 48 \$ 720.00

RECAMBIO DE / SPARE PART OF / PIÈCE DÉTACHÉE DE / RICAMBIO DI / PEÇA DE REPOSIÇÃO DE / ERSATZTEIL FÜR / ONDERDEEL VAN 2400124, 2400125, 2400175

341 06 12 \$ 310.00

RECAMBIO DE / SPARE PART OF / PIÈCE DÉTACHÉE DE / RICAMBIO DI / PEÇA DE REPOSIÇÃO DE / ERSATZTEIL FÜR / ONDERDEEL VAN 2400143, 2400146, 2400147

341 06 14 \$ 590.00

RECAMBIO DE / SPARE PART OF / PIÈCE DÉTACHÉE DE / RICAMBIO DI / PEÇA DE REPOSIÇÃO DE / ERSATZTEIL FÜR / ONDERDEEL VAN 2400124, 2400125, 2400168, 2400175

330 84 00 \$ 120.00

ACCESORIO SUJECIÓN CONTAINER / CONTAINER MOUNTING SET / KIT FIXATION CONTAINER / KIT COMPLETO FISSAGGIO A MURO CESTINO / CONJUNTO FIXAÇÃO PAREDE EMBELEZADOR / WANDKORB FIXIERUNGSSET / MONTAGESET REKJE

341 00 64 \$ 320.00

RECAMBIO DE / SPARE PART OF / PIÈCE DÉTACHÉE DE / RICAMBIO DI / PEÇA DE REPOSIÇÃO DE / ERSATZTEIL FÜR / ONDERDEEL VAN 2400148, 2400149, 2400150, 2400187, 2400188, 2400189

JUEGO BIS SUJECIÓN (M5/M6) / SCREW MOUNTING SET (M5/M6) / SET VIS FIXATION (M5/M6) / KIT VITE FISSAGGIO (M5/M6) / CONJUNTO BIS FIXAÇÃO (M5/M6) / MADENSCHRAUBENSSET (M5/M6) / MONTAGESET (M5/M6)

330 91 00 \$ 60.00

JABONERA / SOAP DISH / PORTE-SAVON / PORTASAPONE / SABONETEIRA / SEIFENSCHALE / ZEEPBAKJE

330 60 00 Mate / Matte / Mat / Satinato / Mate / Matt / Mat \$ 460.00

RECAMBIO DE / SPARE PART OF / PIÈCE DÉTACHÉE DE / RICAMBIO DI / PEÇA DE REPOSIÇÃO DE / ERSATZTEIL FÜR / ONDERDEEL VAN 2400132

VASO / GLASS / VERRE / BICCHIERE / COPO / ZAHNPUTZBECHER / BEKER

330 27 31 Mate / Matte / Mat / Satinato / Mate / Matt / Mat \$ 300.00

RECAMBIO DE / SPARE PART OF / PIÈCE DÉTACHÉE DE / RICAMBIO DI / PEÇA DE REPOSIÇÃO DE / ERSATZTEIL FÜR / ONDERDEEL VAN 2400152

BOMBA DOSIFICADOR / DISPENSER PUMP / POMPE PORTE-SAVON LIQUIDE / POMPETTA DISPENSER / BOMBA DISPENSADOR / DOSIERPUMPE SEIFENSPENDER / DOSEERPOMPE

341 06 22 \$ 140.00

RECAMBIO DE / SPARE PART OF / PIÈCE DÉTACHÉE DE / RICAMBIO DI / PEÇA DE REPOSIÇÃO DE / ERSATZTEIL FÜR / ONDERDEEL VAN 2510104, 2510105

PULSADOR+BOMBA DOSIFICADOR / DISPENSER PUSH BUTTON + PUMP / POUSSOIR + POMPE PORTE-SAVON LIQUIDE / PULSANTE + POMPETTA DISPENSER / BOTÃO + BOMBA DOSEADOR / PUMPENKOPF FÜR SEIFENSPENDER / DRUKKNOP + POMP VERDELER VLOEIBARE ZEEP

340 90 20 \$ 710.00

RECAMBIO DE / SPARE PART OF / PIÈCE DÉTACHÉE DE / RICAMBIO DI / PEÇA DE REPOSIÇÃO DE / ERSATZTEIL FÜR / ONDERDEEL VAN 2510104, 2510105

ESTANTE / SHELF / TABLETTE / MENSOLA / PRATELEIRA / ABLAGE / REK 57,5 CM / INCH 22.6

330 31 30 Mate / Matte / Mat / Satinato / Mate / Matt / Mat \$ 1,350.00

RECAMBIO DE / SPARE PART OF / PIÈCE DÉTACHÉE DE / RICAMBIO DI / PEÇA DE REPOSIÇÃO DE / ERSATZTEIL FÜR / ONDERDEEL VAN 2400145

VASO ESCOBILLERO / TOILET BRUSH GLASS / VERRE PORTE-BALAYETTE / BICCHIERE PORTASCPINO / COPO PORTA-PIACABA / GLAS TOILETTENBÜRSTENHALTER / WC-BORSTELHOUDERPOT

330 83 00 Mate / Matte / Mat / Satinato / Mate / Matt / Mat \$ 500.00

RECAMBIO DE / SPARE PART OF / PIÈCE DÉTACHÉE DE / RICAMBIO DI / PEÇA DE REPOSIÇÃO DE / ERSATZTEIL FÜR / ONDERDEEL VAN 2400100

PALO ESCOBILLERO CON CEPILLO / TOILET BRUSH STICK WITH BRUSH / MANCHE BALAYETTE AVEC BROSSE / MANICO SCOPINO CON SPAZZOLINO / ESCOVA COM CABO PORTA-PIACABA / TOILETTENBÜRSTE MIT GRIFF / HANDVAT MET BORSTEL

340 04 01 \$ 700.00

RECAMBIO DE / SPARE PART OF / PIÈCE DÉTACHÉE DE / RICAMBIO DI / PEÇA DE REPOSIÇÃO DE / ERSATZTEIL FÜR / ONDERDEEL VAN 2400100

340 90 17 \$ 840.00

RECAMBIO DE / SPARE PART OF / PIÈCE DÉTACHÉE DE / RICAMBIO DI / PEÇA DE REPOSIÇÃO DE / ERSATZTEIL FÜR / ONDERDEEL VAN 2510100

CEPILLO ESCOBILLERO / TOILET BRUSH BRUSH / BROSSE PORTE-BALAYETTE / SPAZZOLINO PORTASCPINO / ESCOVA PARA PIACABA / TOILETTENBÜRSTENKOPF / BORSTEL WC-BORSTELHOUDER

350 11 00 Blanco / White / Blanc / Bianco / Branco / Weiss / Wit \$ 280.00

341 03 13 Negro / Black / Noir / Nero / Preto / Schwarz / Zwart \$ 280.00

RECAMBIO DE / SPARE PART OF / PIÈCE DÉTACHÉE DE / RICAMBIO DI / PEÇA DE REPOSIÇÃO DE / ERSATZTEIL FÜR / ONDERDEEL VAN 2400100, 2510100

TACO PLADUR / DRYWALL ANCHOR / CHEVILLE PLACOPLÂTRE / TASSELLO CARTONGESSO / TACO PLADUR / DÜBEL FÜR RIGIPS-PLATTEN / GIPSPLAAT PLUG

341 06 36 \$ 150.00

RECAMBIO DE / SPARE PART OF / PIÈCE DÉTACHÉE DE / RICAMBIO DI / PEÇA DE REPOSIÇÃO DE / ERSATZTEIL FÜR / ONDERDEEL VAN 2400100, 2400121, 2400132, 2400143, 2400145, 2400146, 2400147, 2400148, 2400149, 2400150, 2400152, 2400158, 2400159, 2400161, 2400164, 2400165, 2400166, 2400168, 2400171, 2400172, 2400173, 2400174, 2400175, 2400186, 2400187, 2400188, 2400189



Piezas **sin aristas**, modeladas por y para su uso. Su **diseño** se inspira en la erosión del agua y en cómo ésta **difumina** los contornos y los **moldea** dulcificando los perfiles.

*Pieces **without edges**, moulded by and for use. Their **design** is inspired by the erosion of water, its **blurring** of contours and how they are **moulded** to sweeten their profiles.*

orga nics

DESIGN BY RICARD FERRER

organics

Codificación / Code /
Codification / Codice / Codificação /
Kodifizierung / Codificatie

258 AA 21

COLECCIÓN / COLLECTION / COLLECTION /
COLLEZIONE / COLEÇÃO / KOLLEKTION / COLLECTIE

ACABADOS / FINISHES / FINITIONS / FINITURE / ACABAMENTOS /
OBERFLÄCHEN / AFWERKINGEN

MODELO / TYPE / MODÈLE / MODEL / MODELO / MODELL / MODEL



Características

Fácil instalación: tornillo de doble paso.
Fijaciones ocultas. Anticorrosión.
Estante de vidrio templado (alta seguridad).

Features

Easy installation: double pitch screw.
Hidden attachments. Anti-corrosion.
Tempered glass shelf (high safety).

Caractéristiques :

Facile installation : vis à double pas.
Fixations occultes. Anti-corrosion.
Tablette de verre trempé (haute sécurité).

Caratteristiche:

Facile installazione : vite a doppio passo.
Fissaggio nascolto. Anticorrosivo.
Mensola di vetro temperato (alta sicurezza).

Características:

Fácil instalação: parafuso de dupla passagem.
Fixações ocultas. Anti-corrosão. Estante de vidro temperado (alta segurança).

Eigenschaften:

Einfache montage: doppel-pass-schraube.
Unsichtbare Befestigungen. Korrosionsschutz.
Ablage aus gehärtetem Sicherheitsglass.

Kenmerken:

Eenvoudig te monteren: schroef met dubbele draad. Verborgene bevestigingen. Corrosiewerend. Plank van gehard glas (hoogbeveiligd).

Acabados

Finishes

Finitions

Finiture

Acabamentos

Oberflächen

Afwerkingen



Cromo
Chrome
Chrome
Cromo
Cromo
Chrom
Verchromd



06
Cromo-Negro
Chrome-Black
Chrome-Noir
Cromo-Nero
Cromo-Preto
Chrom-Schwarz
Verchromd-Zwart



79
Cromo-Visión
Chrome-Mink
Chrome-Vision
Cromo-Visone
Cromo-Vison
Chrom-Nerz
Verchromd-Muisgrijs



05
Cromo-Blanco
Chrome-White
Chrome-Blanc
Cromo-Bianco
Cromo-Branco
Chrom-Weiss
Verchromd-Wit



66
Cromo-Blanco roto
Chrome-Off white
Chrome-Blanc cassé
Cromo-Bianco rotto
Cromo-Branco sujo
Chrom-Beigeweiss
Verchromd-Off white



organics

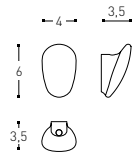

INCH 1.6x1.4x2.4

- COLGADOR
HANGER
PATÈRE
APPENDINO
CABIDE
HAKEN
KLEERHAAK
- 258 01 21**
\$ 790.00

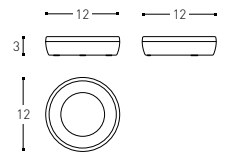

INCH 4.7x4.7x1.2

- ▲ JABONERA
SOAP DISH
PORTE-SAVON
PORTASAPONE
SABONETEIRA
SEIFENSCHALE
ZEEPPAKJE
- 258 AA 32**
\$ 810.00

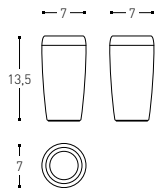

INCH 2.7x2.7x5.3

- ▲ VASO
GLASS
VERRE
BICCHIERE
COPO
BECHER
BEKER
- 258 AA 51**
\$ 970.00

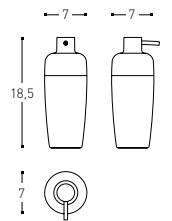

INCH 2.7x2.7x7.3

- ▲ DOSIFICADOR
SOAP DISPENSER
PORTE-SAVON LIQUIDE
DISPENSER
DOSEADOR SABONETE
SEIFENSPENDER
DOSEERDER
- 258 AA 04**
\$ 1,300.00

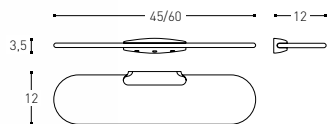

INCH 17.7/23.6x4.7x1.4

- ◆ ESTANTE
SHELF
TABLETTE
MENSOLA
PRATELEIRA
ABLAGE
REK
- 258 01 44 45 CM / INCH 17.7**
\$ 1,460.00
- 258 01 45 60 CM / INCH 23.6**
\$ 1,760.00

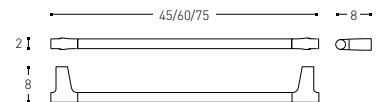
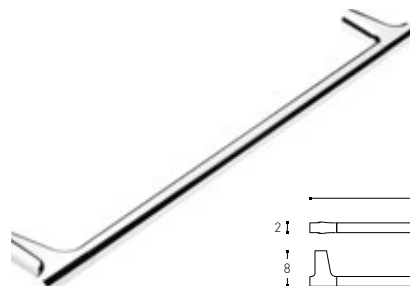

INCH 17.7/23.6/29.6x3.1x0.8

- TOALLERO
TOWEL RACK
PORTE - SERVIETTE
PORTASALVIETTE
TOALHEIRO
HANDTUCHSTANGE
HANDDOEKHOUDER
- 258 01 64 45 CM / INCH 17.7**
\$ 1,940.00
- 258 01 65 60 CM / INCH 23.6**
\$ 2,240.00
- 258 01 66 75 CM / INCH 29.6**
\$ 2,460.00

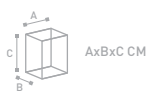

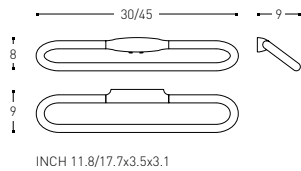

- TOALLERO ARO
- TOWEL RING
- PORTE-SERVIETTE ANNEAU
- PORTASALVIETTE ANELLO
- TOALHEIRO ARGOLA
- HANDTUCHRING
- HANDDOEKRING
- 258 01 71 30 CM / INCH 11.8**
- \$ 1,940.00**
- 258 01 72 45 CM / INCH 17.7**
- \$ 2,240.00**

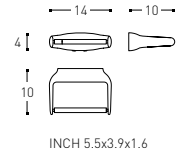

- PORTAPAPEL SIN TAPA
- PAPER HOLDER WITHOUT COVER
- PORTE-ROULEAUX SANS COUVERCLE
- PORTAROTOLO SENZA COPERCHIO
- PORTA-ROLO SEM TAPA
- ROLLENHALTER OHNE DECKEL
- TOILETROLHOUDER ZONDER KLEP
- 258 01 58**
- \$ 1,760.00**

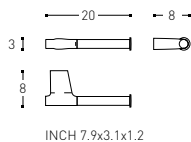

- PORTAPAPEL SIN TAPA
- PAPER HOLDER WITHOUT COVER
- PORTE-ROULEAUX SANS COUVERCLE
- PORTAROTOLO SENZA COPERCHIO
- PORTA-ROLO SEM TAPA
- ROLLENHALTER OHNE DECKEL
- TOILETROLHOUDER ZONDER KLEP
- 258 01 57**
- \$ 1,420.00**

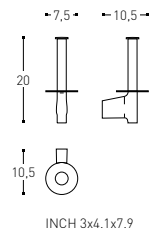

- PORTAPAPEL SIN TAPA VERTICAL
- VERTICAL PAPER HOLDER WITHOUT COVER
- PORTE-ROULEAUX VERTICALE SANS COUVERCLE
- PORTAROTOLO SENZA COPERCHIO VERTICALE
- PORTA-ROLO SEM TAPA VERTICAL
- VERTIKAL ROLLENHALTER OHNE DECKEL
- VERTIKAAL TOILETROLHOUDER ZONDER KLEP
- 258 01 96**
- \$ 1,530.00**

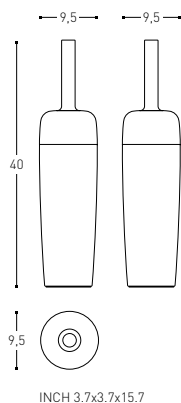

- ▲
- ESCOBILLERO SUELO
- FLOOR TOILET BRUSH
- PORTE-BALAYETTE SOL
- PORTASCIOPINO A TERRA
- PORTA-PIAÇABA SOLO
- TOILETTENBÜRSTENHALTER BODEN
- WC-BORSTELHOUDER VLOER
- 258 AA 00**
- \$ 2,580.00**

organics

recambios spare parts pièces détachées ricambi peças de reposição ersatzteile reserveonderdelen

ACCESORIO SUJECIÓN PARED COLGADOR/PORTAPAPEL/TOALLERO/ TOALLERO ARO / WALL FIXATION SET HOOK/PAPER HOLDER/TOWEL BAR/ TOWEL RING / SET FIXATION MURALE PATÈRE/PORTE-ROULEAUX/PORTE-SERVLETTE/PORTE-SERVLETTE ANNEAU / SET DI FISSAGGIO A MURO APPENDINO/ PORTAROTOLO/PORTASALVIETTE/PORTASALVIETTE ANELLO / CONJUNTO FIXAÇÃO PAREDE CABIDE/PORTA-ROLO/TOALHEIRO/TOALHEIRO ARGOLA / WANDFIXIERUNGSSET HAKEN/ROLLENHALTER/HANDTUCHSTANGE / HANDTUCHRING / MUUR BEVESTIGINGSSET HAKEN/TOILETROLHOUDER HANDDOEKHOUDER HANDDOEKRING

341 02 09 \$ 100.00

RECAMBIO DE / SPARE PART OF / PIÈCE DÉTACHÉE DE / RICAMBIO DI / PEÇA DE REPOSIÇÃO DE / ERSATZTEIL FÜR / ONDERDEEL VAN 2580121, 2580164, 2580165, 2580166, 2580171, 2580172, 2580158, 2580157

ACCESORIO SUJECIÓN ESTANTE / SHELF MOUNTING SET / KIT FIXATION TABLETTE / ACCESSORIO DI FISSAGGIO MENSOLA / CONJUNTO FIXAÇÃO PRATELEIRA / ABLAGEFIXIERUNGSSET / MONTAGESSET REK

341 03 14 \$ 120.00

RECAMBIO DE / SPARE PART OF / PIÈCE DÉTACHÉE DE / RICAMBIO DI / PEÇA DE REPOSIÇÃO DE / ERSATZTEIL FÜR / ONDERDEEL VAN 2580144, 2580145

ACCESORIO SUJECIÓN TOALLERO ARO / TOWEL RING FIXATION SET / SET FIXATION PORTE-SERVLETTE ANNEAU / ACCESSORI DI FISSAGGIO PER PORTASALVIETTE ANELO / ACESSÓRIO DE FIXAÇÃO PARA TOALHEIRO DE ARGOLA / BEFESTIGUNG FÜR HANDTUCHRING / MONTAGESSET HANDDOEKRING

341 03 15 \$ 120.00

RECAMBIO DE / SPARE PART OF / PIÈCE DÉTACHÉE DE / RICAMBIO DI / PEÇA DE REPOSIÇÃO DE / ERSATZTEIL FÜR / ONDERDEEL VAN 2580171, 2580172

ACCESORIO SUJECIÓN TOALLERO / TOWEL BAR MOUNTING SET / KIT FIXATION PORTE-SERVLETTE / ACCESSORIO FISSAGGIO PORTASALVIETTE / CONJUNTO FIXAÇÃO TOALHEIRO / HANDTUCHSTANGFIXIERUNGSSET / MONTAGESSET HANDDOEKHOUDER

341 03 16 \$ 100.00

RECAMBIO DE / SPARE PART OF / PIÈCE DÉTACHÉE DE / RICAMBIO DI / PEÇA DE REPOSIÇÃO DE / ERSATZTEIL FÜR / ONDERDEEL VAN 2580164, 2580165, 2580166

ACCESORIO SUJECIÓN / MOUNTING SET / KIT FIXATION / ACCESSORIO FISSAGGIO / CONJUNTO FIXAÇÃO / FIXIERUNGSSET / MONTAGESSET

341 04 40 \$ 120.00

RECAMBIO DE / SPARE PART OF / PIÈCE DÉTACHÉE DE / RICAMBIO DI / PEÇA DE REPOSIÇÃO DE / ERSATZTEIL FÜR / ONDERDEEL VAN 2580157, 2580196

PULSADOR + BOMBA DOSIFICADOR / DISPENSER PUSH BUTTON + PUMP / POUSSOIR + POMPE PORTE-SAVON LIQUIDE / PULSANTE + POMPETTA DISPENSER / BOTÃO + BOMBA DOSEADOR / PUMPENKOPF FÜR SEIFENSPENDER / DRUKKNOP + POMP VERDELER VLOEIBARE ZEEP

341 06 18 \$ 300.00

RECAMBIO DE / SPARE PART OF / PIÈCE DÉTACHÉE DE / RICAMBIO DI / PEÇA DE REPOSIÇÃO DE / ERSATZTEIL FÜR / ONDERDEEL VAN 2580504, 2580604, 2586604, 2587904

BOMBA DOSIFICADOR / DISPENSER PUMP / POMPE PORTE-SAVON LIQUIDE / POMPETTA DISPENSER / BOMBA DISPENSADOR / DOSIERPUMPE SEIFENSPENDER / DOSEERPOMPJE

341 06 22 \$ 140.00

RECAMBIO DE / SPARE PART OF / PIÈCE DÉTACHÉE DE / RICAMBIO DI / PEÇA DE REPOSIÇÃO DE / ERSATZTEIL FÜR / ONDERDEEL VAN 2580504, 2580604, 2586604, 2587904

ESTANTE / SHELF / TABLETTE / MENSOLA / PRATELEIRA / ABLAGE / REK

45 CM / INCH 17.7

341 03 17 Fumé / Smoked / Fumé / Fumé / Fumado / Smoked / Rauchglas \$ 1,110.00

RECAMBIO DE / SPARE PART OF / PIÈCE DÉTACHÉE DE / RICAMBIO DI / PEÇA DE REPOSIÇÃO DE / ERSATZTEIL FÜR / ONDERDEEL VAN 2580144

60 CM / INCH 23.6

341 03 18 Fumé / Smoked / Fumé / Fumé / Fumado / Smoked / Rauchglas \$ 1,740.00

RECAMBIO DE / SPARE PART OF / PIÈCE DÉTACHÉE DE / RICAMBIO DI / PEÇA DE REPOSIÇÃO DE / ERSATZTEIL FÜR / ONDERDEEL VAN 2580145

EJE PORTAPAPEL ORGANICS / CROSS AXIS PAPER HOLDER ORGANICS / AXEPORTE-ROULEAUX ORGANICS / ASSE PORTAROTOLO ORGANICS / EJE PORTA ROLO ORGANICS / QUERACHSE ROLLENHALTER ORGANICS ORGANICS / HAAKSE TOILETROLHOUDER ORGANICS

341 91 07 \$ 230.00

RECAMBIO DE / SPARE PART OF / PIÈCE DÉTACHÉE DE / RICAMBIO DI / PEÇA DE REPOSIÇÃO DE / ERSATZTEIL FÜR / ONDERDEEL VAN 2580158

PALO ESCOBILLERO CON CEPILLO / TOILET BRUSH STICK WITH BRUSH / MANCHE BALAYETTE AVEC BROUSSE / MANICO SCOPINO CON SPAZZOLINO / ESCOVA COM CABO PORTA-PIAÇABA / TOILETTENBÜRSTE MIT GRIFF / HANDVAT MET BORSTEL

341 03 11 Blanco / White / Blanc / Bianco / Branco / Weiss / Wit \$ 970.00

RECAMBIO DE / SPARE PART OF / PIÈCE DÉTACHÉE DE / RICAMBIO DI / PEÇA DE REPOSIÇÃO DE / ERSATZTEIL FÜR / ONDERDEEL VAN 2580500

341 03 12 Negro / Black / Noir / Nero / Preto / Schwarz / Zwart \$ 970.00

RECAMBIO DE / SPARE PART OF / PIÈCE DÉTACHÉE DE / RICAMBIO DI / PEÇA DE REPOSIÇÃO DE / ERSATZTEIL FÜR / ONDERDEEL VAN 2580600

341 04 23 Blanco roto / Off white / Blanc cassé / Bianco rotto / Branco sujo / Beigeweiss / Off white \$ 990.00

RECAMBIO DE / SPARE PART OF / PIÈCE DÉTACHÉE DE / RICAMBIO DI / PEÇA DE REPOSIÇÃO DE / ERSATZTEIL FÜR / ONDERDEEL VAN 2586600

341 04 24 Visón / Mink / Vison / Visone / Vison / Nerz / Nerts \$ 990.00

RECAMBIO DE / SPARE PART OF / PIÈCE DÉTACHÉE DE / RICAMBIO DI / PEÇA DE REPOSIÇÃO DE / ERSATZTEIL FÜR / ONDERDEEL VAN 2587900

CEPILLO ESCOBILLERO / TOILET BRUSH BRUSH / BROUSSE PORTE-BALAYETTE / SPAZZOLINO PORTASCOPINO / ESCOVA PARA PIAÇABA / TOILETTENBÜRSTENKOPF / BORSTEL WC-BORSTELHOUDER

341 03 13 Negro / Black / Noir / Nero / Preto / Schwarz / Zwart \$ 280.00

350 11 00 Blanco / White / Blanc / Bianco / Branco / Weiss / Wit \$ 280.00

RECAMBIO DE / SPARE PART OF / PIÈCE DÉTACHÉE DE / RICAMBIO DI / PEÇA DE REPOSIÇÃO DE / ERSATZTEIL FÜR / ONDERDEEL VAN 2580500, 2580600, 2586600, 2587900

TACO PLADUR / DRYWALL ANCHOR / CHEVILLE PLACOPLÂTRE / TASSELLO CARTONGESSO / TACO PLADUR / DÜBEL FÜR RIGIPS-PLATTEN / GIPSPLAAT PLUG

341 06 36 \$ 150.00

RECAMBIO DE / SPARE PART OF / PIÈCE DÉTACHÉE DE / RICAMBIO DI / PEÇA DE REPOSIÇÃO DE / ERSATZTEIL FÜR / ONDERDEEL VAN 2580121, 2580144, 2580145, 2580157, 2580158, 2580164, 2580165, 2580166, 2580171, 2580172, 2580196





De la conjugación de formas
circulares y **cuadradas**,
surge la **versatilidad**
y **funcionalidad**
de todos sus elementos.

*From the amalgamation of
circular and **squared** forms
comes the **versatility** and
functionality of all
its elements.*



DESIGN BY COSMICSTUDIO project

project

Codificación / Code /
Codification / Codice / Codificação /
Kodifizierung / Codificatie

251 AA 21

COLECCIÓN / COLLECTION / COLLECTION /
COLLEZIONE / COLEÇÃO / KOLLEKTION / COLLECTIE

ACABADOS / FINISHES / FINITIONS / FINITURE / ACABAMENTOS /
OBERFLÄCHEN / AFWERKINGEN

MODELO / TYPE / MODÈLE / MODEL / MODELO / MODELL / MODEL



Características

Fácil instalación: tornillo de doble paso.
Fijaciones ocultas. Barras de apoyo: diseño reforzado para minusválidas: 150 kgs.
Anticorrosión.

Features

*Easy installation: double pitch screw.
Hidden attachments. Support bars: reinforced design for disabled people: 150kg. Anti-corrosion.*

Caractéristiques :

Facile installation : vis à double pas. Fixations occultes. Barres d'appui : design renforcé pour personnes à mobilités réduites : 150 kgs.
Anti-corrosion.

Caratteristiche:

*Facile installazione : vite a doppio passo.
Fissaggio nascosto. Sbarra d'appoggio : design rinforzato per persone a mobilità ridotta : 150 chili.
Anticorrosivo.*

Características:

Fácil instalação: parafuso de dupla passagem.
Fixações ocultas. Barras de apoio: desenho reforçado para perdas: 150 kgs. Anti-corrosão.

Eigenschaften:

*Einfache montage: doppel-pass-schraube.
Unsichtbare Befestigungen. Stützgriff: design mit verstärkung für behinderte: 150 kg.
Korrosionsschutz.*

Kenmerken:

Eenvoudig te monteren: schroef met dubbele draad. Verborgen bevestigingen. Leuning: versterkt ontwerp voor gehandicapten: 150kg. Corrosiewerend.

Acabados

Finishes

Finitions

Finiture

Acabamentos

Oberflächen

Afwerkingen



Cromo
Chrome
Chrome
Cromo
Cromo
Chrom
Verchromd



51
Cromo-Blanco
Chrome-White
Chrome-Blanc
Cromo-Bianco
Cromo-Branco
Chrom-Weiss
Verchromd-Wit



61
Cromo-Negro
Chrome-Black
Chrome-Noir
Cromo-Nero
Cromo-Preto
Chrom-Schwarz
Verchromd-Zwart



project

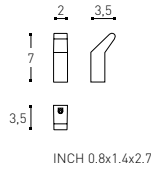

INCH 0.8x1.4x2.7

- COLGADOR
- HANGER
- PATERE
- APPENDINO
- CABIDE
- HAKEN
- KLEERHAAK

MX
251 01 21
\$ 730.00

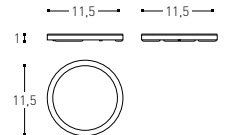

INCH 4.5x4.5x0.4

- △ JABONERA ENCIMERA
- FREE STANDING SOAP DISH
- PORTE-SAVON SUR PLAN
- PORTASAPONE SOPRA PIANO
- SABONETEIRA BANCADA
- AUFLAGESEIFENSCHALE
- ZEEPBAKJE VOOR BLAD

251 AA 34
\$ 1,300.00

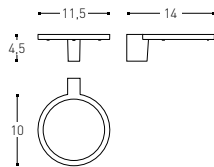

INCH 4.5x5.5x1.8

- △ JABONERA
- SOAP DISH
- PORTE-SAVON
- PORTASAPONE
- SABONETEIRA
- SEIFENSCHALE
- ZEEPBAKJE

251 AA 32
\$ 1,660.00

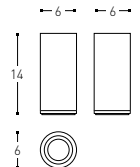

INCH 2.4x2.4x5.5

- △ PORTACEPILLOS ENCIMERA
- FREE STANDING BRUSH-HOLDER
- PORTE-BROSSE À DENT SUR PLAN
- PORTASPAZZOLINI SOPRA PIANO
- PORTA-ESCOVA BANCADA
- AUFLAGEZAHNBÜRSTENHALTER
- TANDENBORSTEKHOUDER VOOR BLAD

251 01 53
\$ 1,460.00

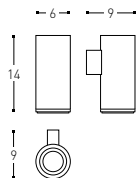

INCH 2.4x3.2x5.5

- △ PORTACEPILLOS
- BRUSH-HOLDER
- PORTE-BROSSE À DENT
- PORTASPAZZOLINI
- PORTA-ESCOVA
- ZAHNBÜRSTENHALTER
- TANDENBORSTEKHOUDER

251 01 54
\$ 1,820.00

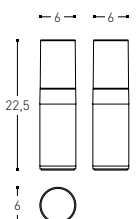

INCH 2.4x2.4x8.8

- △ PORTACEPILLOS CON VASO ENCIMERA
- FREE STANDING BRUSH-HOLDER WITH GLASS
- PORTE-BROSSE À DENT AVEC VERRE SUR PLAN
- PORTASPAZZOLINI CON BICCHIERE SOPRA PIANO
- PORTA-ESCOVA DE DENTES COM COPO BANCADA
- AUFLAGEZAHNBÜRSTENHALTER MIT BECHER
- TANDENBORSTEKHOUDER MET BEKER VOOR BLAD

251 AA 51
\$ 1,620.00



AxBxC CM

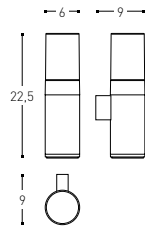

INCH 2.4x3.5x8.8

- ⊙ △ PORTACEPILLOS CON VASO
- BRUSH-HOLDER WITH GLASS
- PORTE-BROSSE À DENT AVEC VERRE
- PORTASPAZZOLINI CON BICCHIERE
- PORTA-ESCOVA DE DENTES COM COPO
- ZAHNBÜRSTENHALTER MIT BECHER
- TANDENBORSTEKHOUDER MET BEKER

251 AA 52
\$ 2,010.00

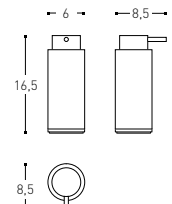

INCH 2.4x3.3x6.5

- ⊙ △ DOSIFICADOR ENCIMERA
- FREE STANDING SOAP DISPENSER
- PORTE-SAVON LIQUIDE SUR PLAN
- DISPENSER SOPRA PIANO
- DISPENSADOR SABONETE BANCADA
- AUFLAGESEIFENSPENDER
- DOSEERDER VOOR BLAD

251 01 04
\$ 1,620.00

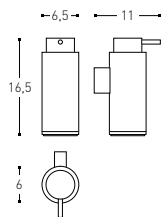

INCH 2.4x4.3x6.5

- ⊙ △ DOSIFICADOR
- SOAP DISPENSER
- PORTE-SAVON LIQUIDE
- DISPENSER
- DISPENSADOR SABONETE
- SEIFENSPENDER
- DOSEERDER

MX 251 01 05
\$ 2,010.00

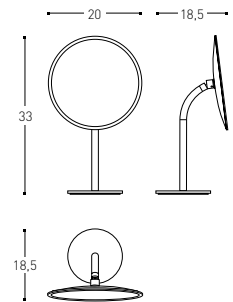

INCH 7.9x7.3x13

- ⊙ △ ◆ ESPEJO AUMENTO ENCIMERA (X3)
- FREE STANDING MAGNIFYING MIRROR (X3)
- MIROIR GROSSISSANT SUR PLAN (X3)
- SPECCHIO AUMENTO SOPRA PIANO (X3)
- ESPELHO AUMENTO BANCADA (X3)
- AUFLAGEVERGRÖßERUNGSSPIEGEL (X3)
- VERGROOTSPIEGEL VOOR BLAD (X3)

251 AA 83
\$ 3,080.00

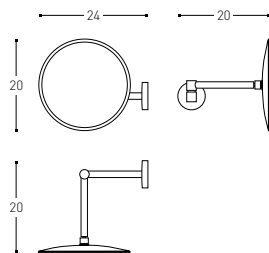

INCH 9.4x7.9x7.9

- ⊙ △ ◆ ESPEJO AUMENTO (X3)
- MAGNIFYING MIRROR (X3)
- MIROIR GROSSISSANT (X3)
- SPECCHIO AUMENTO (X3)
- ESPELHO AUMENTO (X3)
- VERGRÖßERUNGSSPIEGEL (X3)
- VERGROOTSPIEGEL (X3)

MX 251 AA 85
\$ 2,740.00

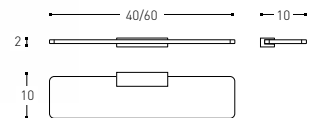

INCH 15.7/23.6x3.9x0.8

- ⊙ ◆ ESTANTE VIDRIO
- GLASS FLAT SHELF
- TABLETTE VERRE
- MENSOLA VETRO
- PRATELEIRA VIDRO
- GLASABLAGE
- GLAZEN REK

MX 251 01 44 40 CM / INCH 15.7
\$ 1,850.00

251 01 45 60 CM / INCH 23.6
\$ 2,030.00

project

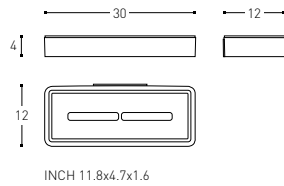

INCH 11.8x4.7x1.6

- CONTAINER
- CONTAINER
- PANIER
- CESTINO
- CONTÊINER
- WANDKORB
- REKJE

MX 251 AA 49
\$ 2,240.00

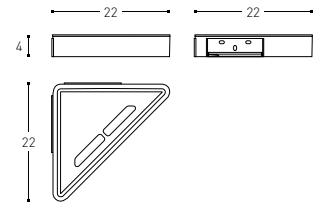

INCH 8.7x8.7x1.6

- CONTAINER RINCÓN
- CORNER CONTAINER
- PANIER ANGLE
- CESTINO ANGOLO
- CONTÊINER DE CANTO
- ECKWANDKORB
- REKJE HOEKVORM

MX 251 AA 50
\$ 2,030.00

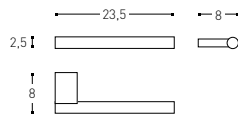

INCH 9.2x3.1x1

- TOALLERO
- TOWEL RACK
- PORTE-SERVIETTE
- PORTASALVIETTE
- TOALHEIRO
- HANDTUCHSTANGE
- HANDDOEKHOUDER

251 01 62
\$ 1,420.00

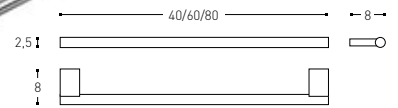
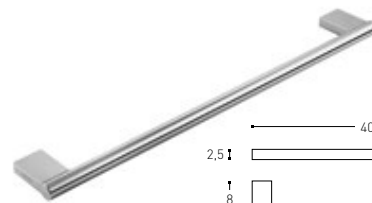

INCH 15.7/23.6/31.5x3.1x1

- TOALLERO
- TOWEL RACK
- PORTE-SERVIETTE
- PORTASALVIETTE
- TOALHEIRO
- HANDTUCHSTANGE
- HANDDOEKHOUDER

MX 251 01 64 40 CM / INCH 15.7
\$ 1,900.00

251 01 66 80 CM / INCH 31.5
\$ 2,310.00

MX 251 01 65 60 CM / INCH 23.6
\$ 2,100.00

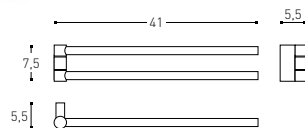

INCH 16.1x2.2x2.9

- TOALLERO DOBLE GIRATORIO
- DOUBLE SWIVEL TOWEL RACK
- PORTE-SERVIETTE PIVOTANT DOBLE
- PORTASALVIETTE A SNODO DOPPIO
- TOALHEIRO GIRATÓRIO DUPLO
- DOPPELTER HANDTUCHSTANGE SCHWENKBAR
- DUBBEL HANDDOEKHOUDER

MX 251 01 75
\$ 3,080.00

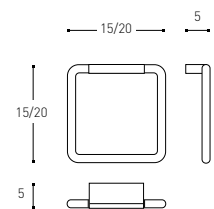

INCH 5.9/7.9x2x5.9/7.9

- TOALLERO ARO
- TOWEL RING
- PORTE-SERVIETTE ANNEAU
- PORTASALVIETTE ANELLO
- TOALHEIRO ARGOLA
- HANDTUCHRING
- HANDDOEKRING

MX 251 01 71 15 CM / INCH 5.9
\$ 1,820.00

251 01 72 20 CM / INCH 7.9
\$ 2,010.00



AxBxC CM

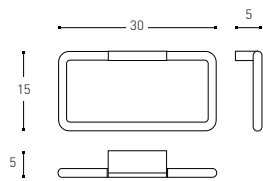

INCH 11.8x2x5.9

- TOALLERO ARO
- TOWEL RING
- PORTE-SERVIETTE ANNEAU
- PORTASALVIETTE ANELLO
- TOALHEIRO ARGOLA
- HANDTUCHRING
- HANDDOEKRING

251 01 82
\$ 2,170.00

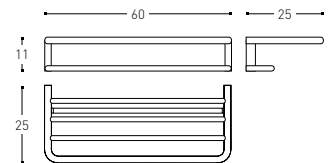

INCH 23.6x9.8x4.3

- TOALLERO ESTANTE
- SHELF TOWEL RACK
- PORTE-LINGE DE BAIN
- PORTASALVIETTE MENSOLA
- TOALHEIRO PRATELEIRA
- HANDTUCHABLAGE
- HANDDOEKREK

251 01 68
\$ 6,400.00

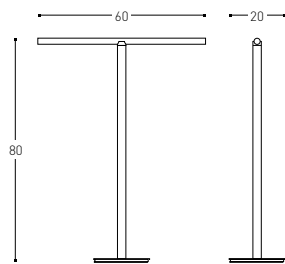

INCH 23.6x7.9x31.5

- TOALLERO DE PIE
- FLOOR STANDING TOWEL RACK
- PORTE-SERVIETTE SUR PIED
- PIANTANA
- TOALHEIRO DE PIE
- HANDTUCHSTÄNDER
- HANDDOEKHOUDER MET VOET

251 01 67
\$ 7,400.00

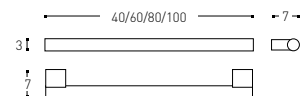

INCH 15.7/23.6/31.5/39.4x2.7x1.2

- ASA BAÑERA
- GRAB BAR
- POIGNÉE BAIGNOIRE
- MANIGLIA VASCA
- ASA BANHEIRA
- WANNENGRIF
- BADRAIL

251 01 24 40 CM / INCH 15.7
\$ 2,470.00

251 01 25 60 CM / INCH 23.6
\$ 2,990.00

251 01 98 80 CM / INCH 31.5
\$ 3,680.00

251 01 99 100 CM / INCH 39.4
\$ 4,340.00

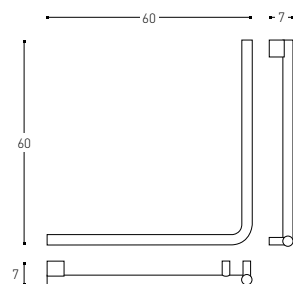

INCH 23.6x2.7x23.6

- ASA BAÑERA ÁNGULO 90°
- 90° ANGLE GRAB BAR
- POIGNÉE BAIGNOIRE ANGLE 90°
- MANIGLIA VASCA ANGOLO 90°
- ASA BANHEIRA ÁNGULO 90°
- WANNENGRIF 90° WINKEL
- BADRAIL 90°

251 01 36
\$ 6,100.00

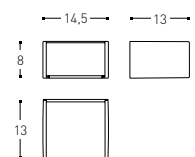

INCH 5.7x5.1x3.1

- PORTAPAPEL CON TAPA
- PAPER HOLDER WITH COVER
- PORTE-ROULEAUX COUVERT
- PORTAROTOLO CON COPERCHIO
- PORTA-ROLO COM TAPA
- ROLLENHALTER MIT DECKEL
- TOILETROLHOUDER MET KLEP

MX 251 01 59
\$ 1,870.00

project

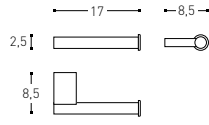

INCH 6.7x3.3x1

- PORTAPAPEL SIN TAPA
- PAPER HOLDER WITHOUT COVER
- PORTE-ROULEAUX SANS COUVERCLE
- PORTAROTOLO SENZA COPERCHIO
- PORTA-ROLO SEM TAPA
- ROLLENHALTER OHNE DECKEL
- TOILETROLHOUDER ZONDER KLEP

MX 251 01 58
\$ 1,420.00

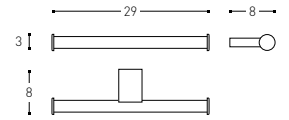

INCH 11.4x3.1x1.2

- PORTAPAPEL DOBLE SIN TAPA
- DOUBLE PAPER HOLDER WITHOUT COVER
- PORTE-ROULEAUX DOUBLE SANS COUVERCLE
- PORTAROTOLO DOPPIO SENZA COPERCHIO
- PORTA-ROLO DUPLO SEM TAPA
- DOPPELTER ROLLENHALTER OHNE DECKEL
- DUBBEL TOILETROLHOUDER ZONDER KLEP

MX 251 01 57
\$ 1,970.00

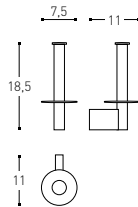

INCH 2.9x4.3x7.3

- △ PORTAPAPEL VERTICAL
- VERTICAL PAPER HOLDER
- PORTE-ROULEAUX VERTICALE
- PORTAROTOLO VERTICALE
- PORTA-ROLO VERTICAL
- VERTIKAL ROLLENHALTER
- VERTIKAAL TOILETROLHOUDER

MX 251 01 96
\$ 1,560.00

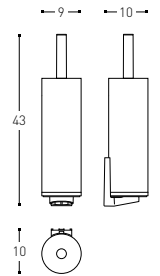

INCH 3.5x3.9x16.9

- ○ △ ESCOBILLERO SUELO/PARED
- FLOOR/WALL TOILET BRUSH
- PORTE-BALAYETTE SOL/MUR
- PORTASCOPINO A TERRA/MURO
- PORTA-PIACABA SOLO/PAREDE
- TOILETTENBÜRSTENHALTER BODEN/WAND
- WC-BORSTELHOUDER VLOER/WAND

251 01 00
\$ 2,720.00

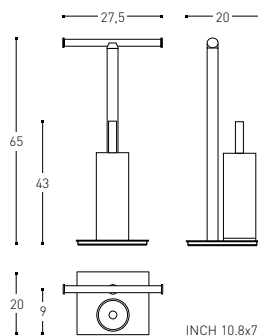

INCH 10.8x7.9x25.6

- ○ △ ESCOBILLERO/PORTAPAPEL SUELO
- FLOOR TOILET BRUSH/PAPER HOLDER
- PORTE-BALAYETTE/PORTE-ROULEAUX SOL
- PORTASCOPINO/PORTAROTOLO SUOLO
- PORTA-PIACABA/ PORTA-ROLO SOLO
- TOILETTENBÜRSTENHALTER/ROLLENABLAGE BODEN
- WC-BORSTELHOUDER/TOILETROLHOUDER VLOER

251 01 97
\$ 9,100.00



AxBxC CM

project

recambios spare parts pièces détachées ricambi peças de reposição ersatzteile reserveonderdelen

ACCESORIO SUJECIÓN PARED / WALL MOUNTING SET / KIT FIXATION MURALE / ACCESSORIO FISSAGGIO MURO / CONJUNTO FIXAÇÃO PAREDE / WANDFIXIERUNGSSET / MONTAGESET WAND

341 01 21 \$ 120.00

RECAMBIO DE / SPARE PART OF / PIÈCE DÉTACHÉE DE / RICAMBIO DI / PEÇA DE REPOSIÇÃO DE / ERSATZTEIL FÜR / ONDERDEEL VAN 2510121, 2510157, 2510158, 2510162, 2510164, 2510165, 2510166, 2515132, 2516132

ACCESORIO SUJECIÓN TRIPLE / TRIPLE MOUNTING SET / KIT TRIPLE FIXATION / ACCESSORIO TRIPLO FISSAGGIO / CONJUNTO FIXAÇÃO TRIPLO / DREIFACHFIXIERUNGSSET / TRIPLE MONTAGESET

341 01 22 \$ 230.00

RECAMBIO DE / SPARE PART OF / PIÈCE DÉTACHÉE DE / RICAMBIO DI / PEÇA DE REPOSIÇÃO DE / ERSATZTEIL FÜR / ONDERDEEL VAN 2510168, 2510175

ACCESORIO SUJECIÓN BARRA DE APOYO / SUPPORT BAR WALL MOUNTING SET / KIT FIXATION BARRE DE SOUTIEN / FISSAGGIO BARRA D'APPOGGIO / CONJUNTO FIXAÇÃO BARRA DE APOYO / WANDFIXIERUNGSSET STÜTZGRIFF / WANDSTEUN MONTAGESET

341 01 23 \$ 230.00

RECAMBIO DE / SPARE PART OF / PIÈCE DÉTACHÉE DE / RICAMBIO DI / PEÇA DE REPOSIÇÃO DE / ERSATZTEIL FÜR / ONDERDEEL VAN 2510124, 2510125, 2510136, 2510137, 2510198, 2510199

ACCESORIO SUJECIÓN BARRA DE APOYO ÁNGULO / ANGLE SUPPORT BAR WALL MOUNTING SET / KIT FIXATION BARRE DE SOUTIEN ANGLE / FISSAGGIO BARRA D'APPOGGIO ANGOLO / CONJUNTO FIXAÇÃO BARRA DE APOYO ÁNGULO / WANDFIXIERUNGSSET STÜTZGRIFF WINKEL / HOEKSTEUN MONTAGESET

341 01 24 \$ 230.00

RECAMBIO DE / SPARE PART OF / PIÈCE DÉTACHÉE DE / RICAMBIO DI / PEÇA DE REPOSIÇÃO DE / ERSATZTEIL FÜR / ONDERDEEL VAN 2510136, 2510137

ACCESORIO SUJECIÓN PLÁSTICO TRIPLE / TRIPLE PLASTIC MOUNTING SET / KIT TRIPLE FIXATION PLASTIQUE / ACCESSORIO TRIPLO FISSAGGIO IN PLASTICA / CONJUNTO FIXAÇÃO PLÁSTICO TRIPLO / KUNSTSTOFF DREIFACHFIXIERUNGSSET / TRIPLE PLASTIC MONTAGESET

341 01 25 \$ 120.00

RECAMBIO DE / SPARE PART OF / PIÈCE DÉTACHÉE DE / RICAMBIO DI / PEÇA DE REPOSIÇÃO DE / ERSATZTEIL FÜR / ONDERDEEL VAN 2510171, 2510172, 2510182

ACCESORIO SUJECIÓN ESTANTE / SHELF MOUNTING SET / KIT FIXATION TABLETTE / ACCESSORIO DI FISSAGGIO MENSOLA / CONJUNTO FIXAÇÃO PRATELEIRA / ABLAGEFIXIERUNGSSET / MONTAGESET REK

341 03 02 \$ 140.00

RECAMBIO DE / SPARE PART OF / PIÈCE DÉTACHÉE DE / RICAMBIO DI / PEÇA DE REPOSIÇÃO DE / ERSATZTEIL FÜR / ONDERDEEL VAN 2510144, 2510145

VASO / GLASS / VERRE / BICCHIERE / COPO / ZAHNPUTZBECHER / BEKER

341 04 33 Blanco / White / Blanc / Bianco / Branco / Weiss / Wit \$ 260.00

RECAMBIO DE / SPARE PART OF / PIÈCE DÉTACHÉE DE / RICAMBIO DI / PEÇA DE REPOSIÇÃO DE / ERSATZTEIL FÜR / ONDERDEEL VAN 2515151, 2515152

341 04 34 Negro / Black / Noir / Nero / Preto / Schwarz / Zwart \$ 260.00

RECAMBIO DE / SPARE PART OF / PIÈCE DÉTACHÉE DE / RICAMBIO DI / PEÇA DE REPOSIÇÃO DE / ERSATZTEIL FÜR / ONDERDEEL VAN 2516151, 2516152

PULSADOR + BOMBA DOSIFICADOR / DISPENSER PUSH BUTTON + PUMP / POUSSOIR + POMPE PORTE-SAVON LIQUIDE / PULSANTE + POMPETTA DISPENSER / BOTÃO + BOMBA DOSEADOR / PUMPENKOPF FÜR SEIFENSPENDER / DRUKKNOP + POMP VERDELER VLOEIBARE ZEEP

340 90 20 Cromo / Chrome / Chromé / Cromo / Cromo / Chrom / Verchroomd \$ 710.00

RECAMBIO DE / SPARE PART OF / PIÈCE DÉTACHÉE DE / RICAMBIO DI / PEÇA DE REPOSIÇÃO DE / ERSATZTEIL FÜR / ONDERDEEL VAN 2510104, 2510105

BOMBA DOSIFICADOR / DISPENSER PUMP / POMPE PORTE-SAVON LIQUIDE / POMPETTA DISPENSER / BOMBA DISPENSADOR / DOSIERPUMPE SEIFENSPENDER / DOSEERPOMPJE

341 06 22 \$ 140.00

RECAMBIO DE / SPARE PART OF / PIÈCE DÉTACHÉE DE / RICAMBIO DI / PEÇA DE REPOSIÇÃO DE / ERSATZTEIL FÜR / ONDERDEEL VAN 2510104, 2510105

LUNA ESPEJO / GLASS MIRROR / GLACE / VETRO SPECCHIO / LUNA ESPELHO / GLASSPIEGEL / GLAS SPIEGEL

341 04 73 Blanco / White / Blanc / Bianco / Branco / Weiss / Wit \$ 590.00

RECAMBIO DE / SPARE PART OF / PIÈCE DÉTACHÉE DE / RICAMBIO DI / PEÇA DE REPOSIÇÃO DE / ERSATZTEIL FÜR / ONDERDEEL VAN 2515183, 2515185

341 04 72 Negro / Black / Noir / Nero / Preto / Schwarz / Zwart \$ 590.00

RECAMBIO DE / SPARE PART OF / PIÈCE DÉTACHÉE DE / RICAMBIO DI / PEÇA DE REPOSIÇÃO DE / ERSATZTEIL FÜR / ONDERDEEL VAN 2516183, 2516185

ESTANTE / SHELF / TABLETTE / MENSOLA / PRATELEIRA / ABLAGE / REK

40 CM / INCH 15.7

341 00 91 Mate / Matte / Mat / Satinado / Mate / Matt / Mat \$ 1260.00

RECAMBIO DE / SPARE PART OF / PIÈCE DÉTACHÉE DE / RICAMBIO DI / PEÇA DE REPOSIÇÃO DE / ERSATZTEIL FÜR / ONDERDEEL VAN 2510144

60 CM / INCH 23.6

341 00 88 Mate / Matte / Mat / Satinado / Mate / Matt / Mat \$ 1,400.00

RECAMBIO DE / SPARE PART OF / PIÈCE DÉTACHÉE DE / RICAMBIO DI / PEÇA DE REPOSIÇÃO DE / ERSATZTEIL FÜR / ONDERDEEL VAN 2510145

EJE PORTAPAPEL / CROSS AXIS PAPER HOLDER / AXE PORTE-ROULEAUX / ASSE PORTAROTOLO / EJE PORTA ROLO / QUERACHSE ROLLENHALTER / HAAKSE TOILETROLHOUDER

341 90 20 \$ 260.00

RECAMBIO DE / SPARE PART OF / PIÈCE DÉTACHÉE DE / RICAMBIO DI / PEÇA DE REPOSIÇÃO DE / ERSATZTEIL FÜR / ONDERDEEL VAN 2510159

PALO ESCOBILLERO CON CEPILLO / TOILET BRUSH STICK WITH BRUSH / MANCHE BALAYETTE AVEC BROSSSE / MANICO SCOPINO CON SPAZZOLINO / ESCOVA COM CABO PORTA-PIAÇABA / TOILETTENBÜRSTE MIT GRIFF / HANDVAT MET BORSTEL

340 90 17 \$ 840.00

RECAMBIO DE / SPARE PART OF / PIÈCE DÉTACHÉE DE / RICAMBIO DI / PEÇA DE REPOSIÇÃO DE / ERSATZTEIL FÜR / ONDERDEEL VAN 2510100, 2510197

CEPILLO ESCOBILLERO / TOILET BRUSH BRUSH / BROSSSE PORTE-BALAYETTE / SPAZZOLINO PORTASCOPINO / ESCOVA PARA PIAÇABA / TOILETTENBÜRSTENKOPF / BORSTEL WC-BORSTELHOUDER

350 11 00 Blanco / White / Blanc / Bianco / Branco / Weiss / Wit \$ 280.00

341 03 13 Negro / Black / Noir / Nero / Preto / Schwarz / Zwart \$ 280.00

RECAMBIO DE / SPARE PART OF / PIÈCE DÉTACHÉE DE / RICAMBIO DI / PEÇA DE REPOSIÇÃO DE / ERSATZTEIL FÜR / ONDERDEEL VAN 2510100, 2510197

TACO PLADUR / DRYWALL ANCHOR / CHEVILLE PLACOPLÂTRE / TASSELLO CARTONGESSO / TACO PLADUR / DÜBEL FÜR RIGIPS-PLATTEN / GIPSPLAAT PLUG

341 06 36 \$ 150.00

RECAMBIO DE / SPARE PART OF / PIÈCE DÉTACHÉE DE / RICAMBIO DI / PEÇA DE REPOSIÇÃO DE / ERSATZTEIL FÜR / ONDERDEEL VAN RECAMBIO DE / SPARE PART OF / PIÈCE DÉTACHÉE DE / RICAMBIO DI / PEÇA DE REPOSIÇÃO DE / ERSATZTEIL FÜR / ONDERDEEL VAN 2515132, 2515149, 2515150, 2515152, 2515185, 2516132, 2516149, 2516150, 2516152, 2516185

341 06 37 \$ 160.00

RECAMBIO DE / SPARE PART OF / PIÈCE DÉTACHÉE DE / RICAMBIO DI / PEÇA DE REPOSIÇÃO DE / ERSATZTEIL FÜR / ONDERDEEL VAN 2510124, 2510125, 2510136, 2510137, 2510198, 2510199



Basada en la **función** pura,
sin más pretensiones. Formas
simples con un gesto
extremadamente **elegante**.

*Based on pure **function**,
without ostentation. **Simple**
forms with an extremely
elegant expression.*



work ing

DESIGN BY COSMIC STUDIO

working



Características

Fácil instalación: tornillo de doble paso.
Fijaciones ocultas. Anticorrosión.

Features

*Easy installation: double pitch screw.
Hidden attachments. Anti-corrosion.*

Caractéristiques :

Facile installation : vis à double pas.
Fixations occultes. Anti-corrosion.

Caratteristiche:

*Facile installazione : vite a doppio passo.
Fissaggio nascosto. Anticorrosivo.*

Características:

Fácil instalação: parafuso de dupla
passagem. Fixações ocultas. Anti-
corrosão.

Eigenschaften:

*Einfache montage: doppel-pass-
schraube. Unsichtbare Befestigungen.
Korrosionsschutz.*

Kenmerken:

Eenvoudig te monteren: schroef met
dubbele draad. Verborgene bevestigingen.
Corrosiewerend.

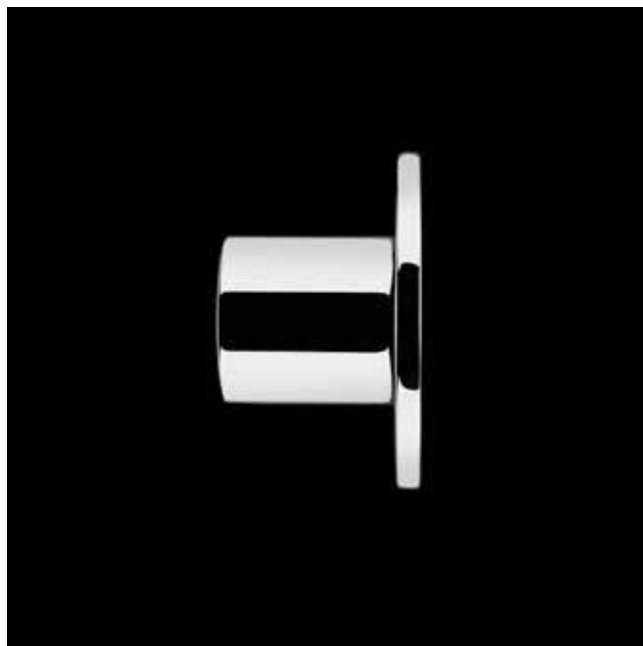

Acabados Finishes Finitions Finiture Acabamentos Oberflächen Afwerkingen



Cromo
Chrome
Chromé
Cromo
Cromo
Chrom
Verchromd



working

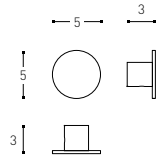

INCH 2x1.2x2

- COLGADOR
- HANGER
- PATÈRE
- APPENDINO
- CABIDE
- HAKEN
- KLEERHAAK
- 238 01 21**
- \$ 960.00**

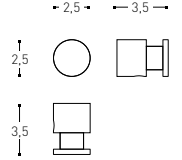

INCH 1x1.4x1

- PORTAGUANTES
- HANGER
- PATÈRE
- APPENDINO
- PORTA-LUVAS
- HAKEN
- KLEERHAAK
- 238 01 20**
- \$ 620.00**

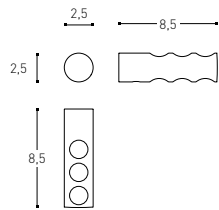

INCH 1x3.3x1

- PORTACEPILLOS
- BRUSH HOLDER
- PORTE-BROSSE À DENTS
- PORTASPAZZOLINI
- PORTA-ESCOVA DE DENTES
- ZAHNBÜRSTENHALTER
- TANDENBORSTELHOUDER
- 238 01 35**
- \$ 1,010.00**

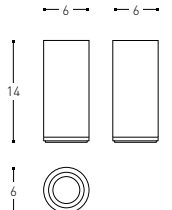

INCH 2.4x2.4x5.5

- △ PORTACEPILLOS ENCIMERA
- FREE STANDING BRUSH-HOLDER
- PORTE-BROSSE À DENTS À POSER
- PORTASPAZZOLINI DA APPOGGIO
- PORTA-ESCOVA DE DENTES DE BAN-
- CADA
- ZAHNBÜRSTENHALTER FÜR AUFLAGE
- TANDENBORSTELHOUDER VOOR BLAD
- 251 01 53**
- \$ 1,460.00**

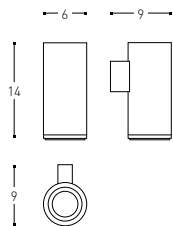

INCH 2.4x3.5x5.5

- △ PORTACEPILLOS
- BRUSH-HOLDER
- PORTE-BROSSE À DENTS
- PORTASPAZZOLINI
- PORTA-ESCOVA DE DENTES
- ZAHNBÜRSTENHALTER
- TANDENBORSTELHOUDER
- 251 01 54**
- \$ 1,820.00**

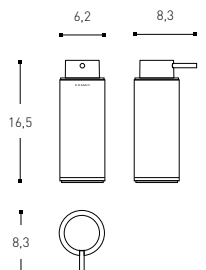

INCH 2.4x3.3x6.5

- DOSIFICADOR ENCIMERA
- FREE STANDING SOAP DISPENSER
- PORTE-SAVON LIQUIDE À POSER
- DISPENSER DA APPOGGIO
- DISPENSADOR SABONETE DE BAN-
- CADA
- AUFLAGESEIFENSPENDER
- DOSEERDER VOOR BLAD
- 251 01 04**
- \$ 1,620.00**

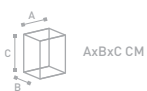

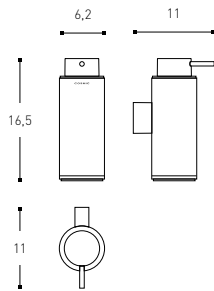

INCH 2.4x4.3x6.5

● DOSIFICADOR
SOAP DISPENSER
PORTE-SAVON LIQUIDE
DISPENSER
DISPENSADOR SABONETE
SEIFENSPENDER
DOSEERDER

251 01 05
\$ 2,010.00

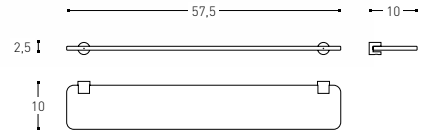

INCH 22.6x3.9x1

◆ ESTANTE VIDRIO
GLASS FLAT SHELF
TABLETTE VERRE
MENSOLA VETRO
PRATELEIRA VIDRO
GLASABLAGE
GLAZEN REK

238 01 45
\$ 2,080.00

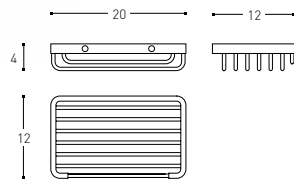

INCH 7.9x4.7x1.6

● CONTAINER
CONTAINER
PANIER
CESTINO
CONTAINER
WANDKORB
REKJE

238 01 86
\$ 1,350.00

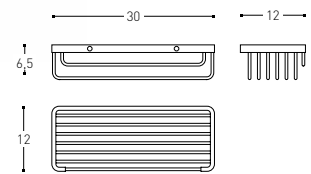

INCH 11.8x4.7x2.5

● CONTAINER
CONTAINER
PANIER
CESTINO
CONTAINER
WANDKORB
REKJE

238 01 49
\$ 1,740.00

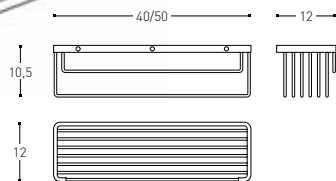
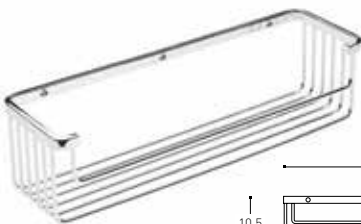

INCH 15.7/19.7x4.7x4.1

● CONTAINER
CONTAINER
PANIER
CESTINO
CONTAINER
WANDKORB
REKJE

238 01 48 40 CM / INCH 15.7
\$ 2,700.00

238 01 88 50 CM / INCH 19.7
\$ 2,920.00

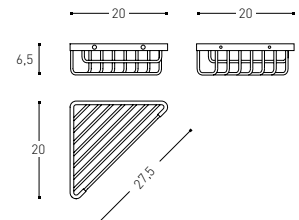

INCH 7.9x7.9x2.5

● CONTAINER RINCÓN
CORNER CONTAINER
PANIER ANGLE
CESTINO ANGOLO
CONTAINER DE CANTO
ECKWANDKORB
REKJE HOEKVORM

238 01 50
\$ 1,560.00

working

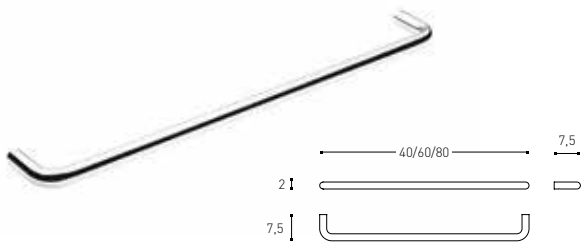

INCH 15.7/23.6/31.5x2.9x0.8

② TOALLERO
TOWEL RACK
PORTE - SERVIETTE
PORTASALVIETTE
TOALHEIRO
HANDTUCHSTANGE
HANDDOEKHOUDER

238 01 64 40 CM / INCH 15.7 \$ 1,740.00

238 01 65 60 CM / INCH 23.6 \$ 1,990.00

238 01 66 80 CM / INCH 31.5 \$ 2,220.00

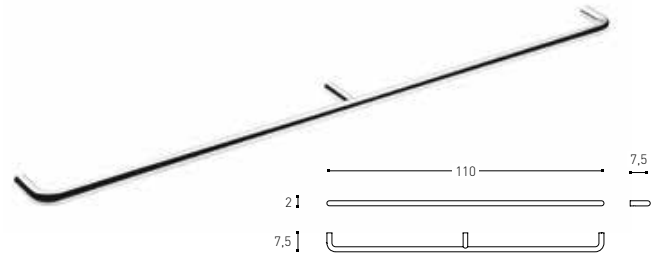

INCH 43.3x2.9x0.8

② TOALLERO
TOWEL RACK
PORTE - SERVIETTE
PORTASALVIETTE
TOALHEIRO
HANDTUCHSTANGE
HANDDOEKHOUDER

**238 01 67
\$ 3,950.00**

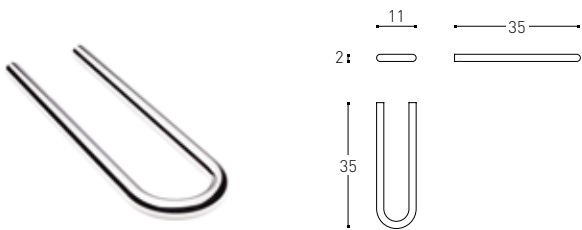

INCH 4.3x13.7x0.8

② TOALLERO DOBLE
DOUBLE TOWEL RACK
PORTE - SERVIETTE DOUBLE
PORTASALVIETTE DOPPIO
TOALHEIRO DUPLO
DOPPELTE HANDTUCHSTANGE
DUBBELE HANDDOEKENHOUDER

**238 01 61
\$ 2,280.00**

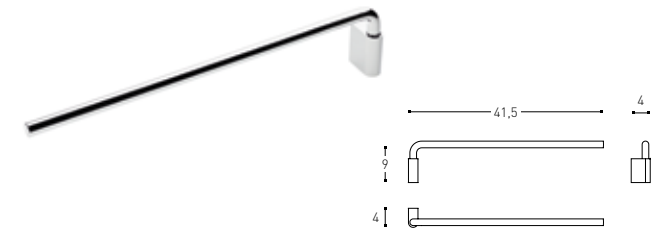

INCH 16.3x1.6x3.5

② TOALLERO GIRATORIO
SWIVEL TOWEL RACK
PORTE - SERVIETTE PIVOTANT
PORTASALVIETTE A SNODO
TOALHEIRO GIRATÓRIO
HANDTUCHSTANGE SCHWENKBAR
HANDDOEKHOUDER DRAAIBAAR

**238 01 74
\$ 1,760.00**

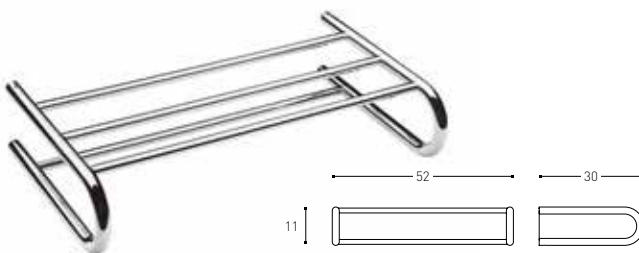

INCH 20.5x11.8x4.3

② TOALLERO ESTANTE
BRACKET-SHELF TOWEL RACK
PORTE-LINGE DE BAIN
PORTASALVIETTE MENSOLA
TOALHEIRO PRATELEIRA
HANDTUCHABLAGE
HANDDOEKREK

**238 01 68
\$ 5,250.00**

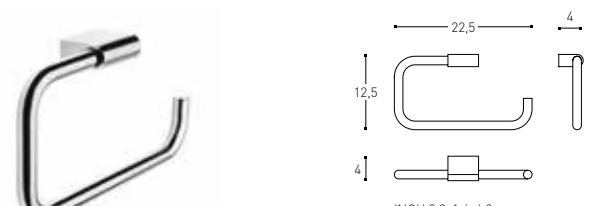

INCH 8.8x1.6x4.9

② TOALLERO ARO
TOWEL RING
PORTE - SERVIETTE ANNEAU
PORTASALVIETTE ANELLO
TOALHEIRO ARGOLA
HANDTUCHRING
HANDDOEKRING

**238 01 71 12,5 CM / INCH 4.9
\$ 1,600.00**



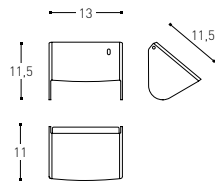

INCH 5.1x4.5x4.5

- ○ PORTAPAPEL CON TAPA
- PAPER HOLDER WITH COVER
- PORTE-ROULEAUX COUVERT
- PORTAROTOLO CON COPERCHIO
- PORTA-ROLO COM TAMPA
- ROLLENHALTER MIT DECKEL
- TOILETROLHOUDER MET KLEP

238 01 59
\$ 1,690.00

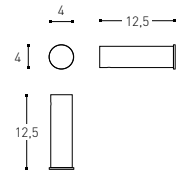

INCH 1.6x4.9x1.6

- ○ PORTAPAPEL SIN TAPA
- PAPER HOLDER WITHOUT COVER
- PORTE-ROULEAUX SANS COUVERCLE
- PORTAROTOLO SENZA COPERCHIO
- PORTA-ROLO SEM TAMPA
- ROLLENHALTER OHNE DECKEL
- TOILETROLHOUDER ZONDER KLEP

238 01 58
\$ 1,260.00

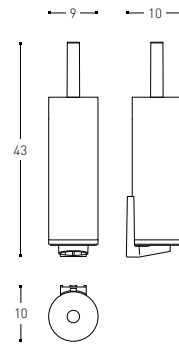

INCH 3.5x3.9x16.9

- ○ △

- ESCOBILLERO SUELO/PARED
- FLOOR/WALL TOILET BRUSH
- PORTE-BALAYETTE SOL/MUR
- PORTASCPINO A TERRA/MURO
- PORTA-PIACABA SOLO/PAREDE
- TOILETTENBÜRSTENHALTER BODEN/WAND
- WC-BORSTELHOUDER VLOER/WAND

251 01 00
\$ 2,720.00

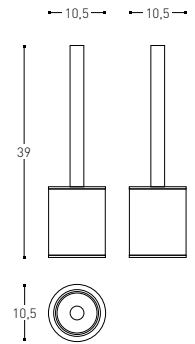

INCH 4.1x4.1x15.3

- ◆

- ESCOBILLERO SUELO
- FLOOR TOILET BRUSH
- PORTE-BALAYETTE SOL
- PORTASCPINO SUOLO
- PORTA-PIACABA SOLO
- TOILETTENBÜRSTENHALTER BODEN
- WC-BORSTELHOUDER VLOER

238 01 00
\$ 3,490.00

working

recambios spare parts pièces détachées ricambi peças de reposição ersatzteile reserveonderdelen

ACCESORIO SUJECCIÓN BÁSICO / BASIC MOUNTING SET / KIT FIXATION DE BASE / ACCESSORIO FISSAGGIO BASE / CONJUNTO FIXAÇÃO BÁSICO / STANDARD FIXIERUNGSSET / MONTAGESET FUNDAMENTEEL

341 00 18 \$ 120.00

RECAMBIO DE / SPARE PART OF / PIÈCE DÉTACHÉE DE / RICAMBIO DI / PEÇA DE REPOSIÇÃO DE / ERSATZTEIL FÜR / ONDERDEEL VAN
2380145, 2380159

ACCESORIO SUJECCIÓN / MOUNTING SET / KIT FIXATION / ACCESSORIO FISSAGGIO / FIXAÇÃO PAREDE / FIXIERUNGSSET / MONTAGESET

340 65 00 \$ 520.00

RECAMBIO DE / SPARE PART OF / PIÈCE DÉTACHÉE DE / RICAMBIO DI / PEÇA DE REPOSIÇÃO DE / ERSATZTEIL FÜR / ONDERDEEL VAN
2380120, 2380161, 2380164, 2380165, 2380166, 2380167

ACCESORIO SUJECCIÓN PARED REDONDO / ROUND WALL MOUNTING SET / KIT FIXATION MURALE ROND / ACCESSORIO FISSAGGIO MURO ROTONDO / CONJUNTO FIXAÇÃO PAREDE REDONDO / WANDFIXIERUNGSSET RUND / MONTAGESET WAND ROND

330 76 00 \$ 140.00

RECAMBIO DE / SPARE PART OF / PIÈCE DÉTACHÉE DE / RICAMBIO DI / PEÇA DE REPOSIÇÃO DE / ERSATZTEIL FÜR / ONDERDEEL VAN
2380168

ACCESORIO SUJECCIÓN PARED (2 TORNILLOS) / WALL MOUNTING SET (2 SCREWS) / KIT FIXATION MURALE (2 VIS) / ACCESSORIO FISSAGGIO MURO (2 VITI) / CONJUNTO FIXAÇÃO PAREDE (2 PARAFUSOS) / WANDFIXIERUNGSSET (2 SCHRAUBEN) / MONTAGESET WAND (2 SCHROEFS)

340 58 00 \$ 520.00

JUEGO BIS SUJECCIÓN (M5/M6) / SCREW MOUNTING SET (M5/M6) / SET VIS FIXATION (M5/M6) / KIT VITE FISSAGGIO (M5/M6) / CONJUNTO BIS FIXAÇÃO (M5/M6) / MADENSCHRAUBENSSET (M5/M6) / MONTAGESET (M5/M6)

330 91 00 \$ 60.00

JABONERA / SOAP DISH / PORTE-SAVON / PORTASAPONE / SABONETEIRA / SEIFENSCHALE / ZEEPBAKJE

340 56 00 Mate / Matte / Mat / Satinato / Mate / Matt / Mat \$ 370.00

RECAMBIO DE / SPARE PART OF / PIÈCE DÉTACHÉE DE / RICAMBIO DI / PEÇA DE REPOSIÇÃO DE / ERSATZTEIL FÜR / ONDERDEEL VAN
2380132

VASO / GLASS / VERRE / BICCHIERE / COPO / ZAHNPUTZBECHER / BEKER

340 55 00 Mate / Matte / Mat / Satinato / Mate / Matt / Mat \$ 440.00

RECAMBIO DE / SPARE PART OF / PIÈCE DÉTACHÉE DE / RICAMBIO DI / PEÇA DE REPOSIÇÃO DE / ERSATZTEIL FÜR / ONDERDEEL VAN
2380152

PULSADOR + BOMBA DOSIFICADOR / DISPENSER PUSH BUTTON + PUMP / POUSSOIR + POMPE PORTE-SAVON LIQUIDE / PULSANTE + POMPETTA DISPENSER / BOTÃO + BOMBA DOSEADOR / PUMPENKOPF FÜR SEIFENSPENDER / DRUKKNOP + POMP VERDELER VLOEIBARE ZEEP

340 90 20 \$ 710.00

RECAMBIO DE / SPARE PART OF / PIÈCE DÉTACHÉE DE / RICAMBIO DI / PEÇA DE REPOSIÇÃO DE / ERSATZTEIL FÜR / ONDERDEEL VAN
2510104, 2510105

BOMBA DOSIFICADOR / DISPENSER PUMP / POMPE PORTE-SAVON LIQUIDE / POMPETTA DISPENSER / BOMBA DISPENSADOR / DOSIERPUMPE SEIFENSPENDER / DOSEERPOMPJE

341 06 22 \$ 140.00

RECAMBIO DE / SPARE PART OF / PIÈCE DÉTACHÉE DE / RICAMBIO DI / PEÇA DE REPOSIÇÃO DE / ERSATZTEIL FÜR / ONDERDEEL VAN
2510104, 2510105

ESTANTE / SHELF / TABLETTE / MENSOLA / PRATELEIRA / ABLAGE / REK 57,5x9 CM / INCH 22.6x3.5

340 66 00 Mate / Matte / Mat / Satinato / Mate / Matt / Mat \$ 1,530.00

RECAMBIO DE / SPARE PART OF / PIÈCE DÉTACHÉE DE / RICAMBIO DI / PEÇA DE REPOSIÇÃO DE / ERSATZTEIL FÜR / ONDERDEEL VAN
2380145

VASO ESCOBILLERO / TOILET BRUSH GLASS / VERRE PORTE-BALAYETTE / BICCHIERE PORTASCOPINO / COPO PORTA-PIAÇABA / GLAS TOILETTENBÜRSTENHALTER / WC-BORSTELHOUDERPOT

330 83 00 Mate / Matte / Mat / Satinato / Mate / Matt / Mat \$ 500.00

RECAMBIO DE / SPARE PART OF / PIÈCE DÉTACHÉE DE / RICAMBIO DI / PEÇA DE REPOSIÇÃO DE / ERSATZTEIL FÜR / ONDERDEEL VAN
2380100

PALO ESCOBILLERO CON CEPILLO / TOILET BRUSH STICK WITH BRUSH / MANCHE BALAYETTE AVEC BROUSSE / MANICO SCOPINO CON SPAZZOLINO / ESCOVA COM CABO PORTA-PIAÇABA / TOILETTENBÜRSTE MIT GRIFF / HANDVAT MET BORSTEL

341 00 60 \$ 1,420.00

RECAMBIO DE / SPARE PART OF / PIÈCE DÉTACHÉE DE / RICAMBIO DI / PEÇA DE REPOSIÇÃO DE / ERSATZTEIL FÜR / ONDERDEEL VAN
2380100

340 90 17 \$ 840.00

RECAMBIO DE / SPARE PART OF / PIÈCE DÉTACHÉE DE / RICAMBIO DI / PEÇA DE REPOSIÇÃO DE / ERSATZTEIL FÜR / ONDERDEEL VAN
2510100

CEPILLO ESCOBILLERO / TOILET BRUSH BRUSH / BROUSSE PORTE-BALAYETTE / SPAZZOLINO PORTASCOPINO / ESCOVA PARA PIAÇABA / TOILETTENBÜRSTENKOPF / BORSTEL WC-BORSTELHOUDER

350 11 00 Blanco / White / Blanc / Bianco / Branco / Weiss / Wit \$ 280.00

341 03 13 Negro / Black / Noir / Nero / Preto / Schwarz / Zwart \$ 280.00

RECAMBIO DE / SPARE PART OF / PIÈCE DÉTACHÉE DE / RICAMBIO DI / PEÇA DE REPOSIÇÃO DE / ERSATZTEIL FÜR / ONDERDEEL VAN
2380100, 2510100

TACO PLADUR / DRYWALL ANCHOR / CHEVILLE PLACOPLÂTRE / TASSELLO CARTONGESSO / TACO PLADUR / DÜBEL FÜR RIGIPS-PLATTEN / GIPSPLAAT PLUG

341 06 36 \$ 150.00

RECAMBIO DE / SPARE PART OF / PIÈCE DÉTACHÉE DE / RICAMBIO DI / PEÇA DE REPOSIÇÃO DE / ERSATZTEIL FÜR / ONDERDEEL VAN
2380120, 2380121, 2380135, 2380145, 2380148, 2380149, 2380150, 2380158, 2380159, 2380161, 2380164, 2380165, 2380166, 2380167, 2380168, 2380171, 2380174, 2380186, 2380188





free standing accessories

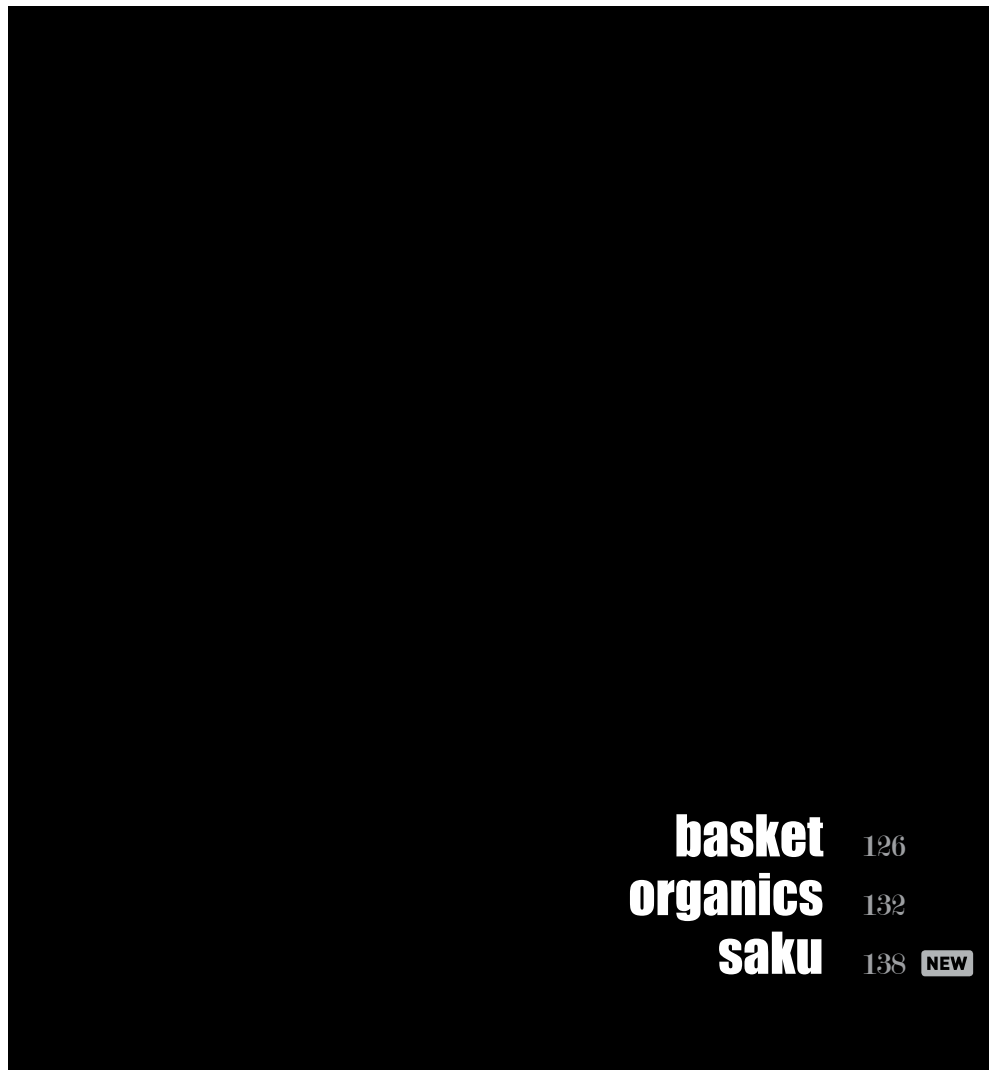

basket 126
organics 132
saku 138 **NEW**



Piezas **discretas**
y **funcionales**,
que ayudan a mantener
el baño **ordenado**.

Modest
and functional
pieces that help to keep
the bathroom **tidy**.

DESIGN BY COSMIC STUDIO

bas ket

basket



Características

Materiales de alta calidad resistentes a la corrosión. Mecanismo de pedal. Cubo interior de plástico extraíble.

Features

Rustproof high quality materials. Pedal mechanism. Removable plastic basket inside.

Caractéristiques :

Matériaux de haute qualité et résistants à la corrosion. Mécanisme à pédale. Récipient intérieur en plastique amovible.

Caratteristiche:

Materiali di alta qualità, resistenti alla corrosione. Meccanismo a pedale. Contenitore interno in plastica estraibile.

Características:

Materiais de alta qualidade resistentes à corrosão. Mecanismo de pedal. Cubo interior de plástico extraível.

Eigenschaften:

Korrosionsbeständige, hochwertige Materialien. Treteimer. Abnehmbarer Kunststoffeinsatz.

Kenmerken:

Hoogwaardige materialen en korrosiebestendig. Pedaalmechanisme. Recipient in uitneembare kunststof.



Acabados Finishes Finitions Finiture Acabamentos Oberflächen Afwerkingen



Cromo
Chrome
Chromé
Cromo
Cromo
Chrom
Verchromd

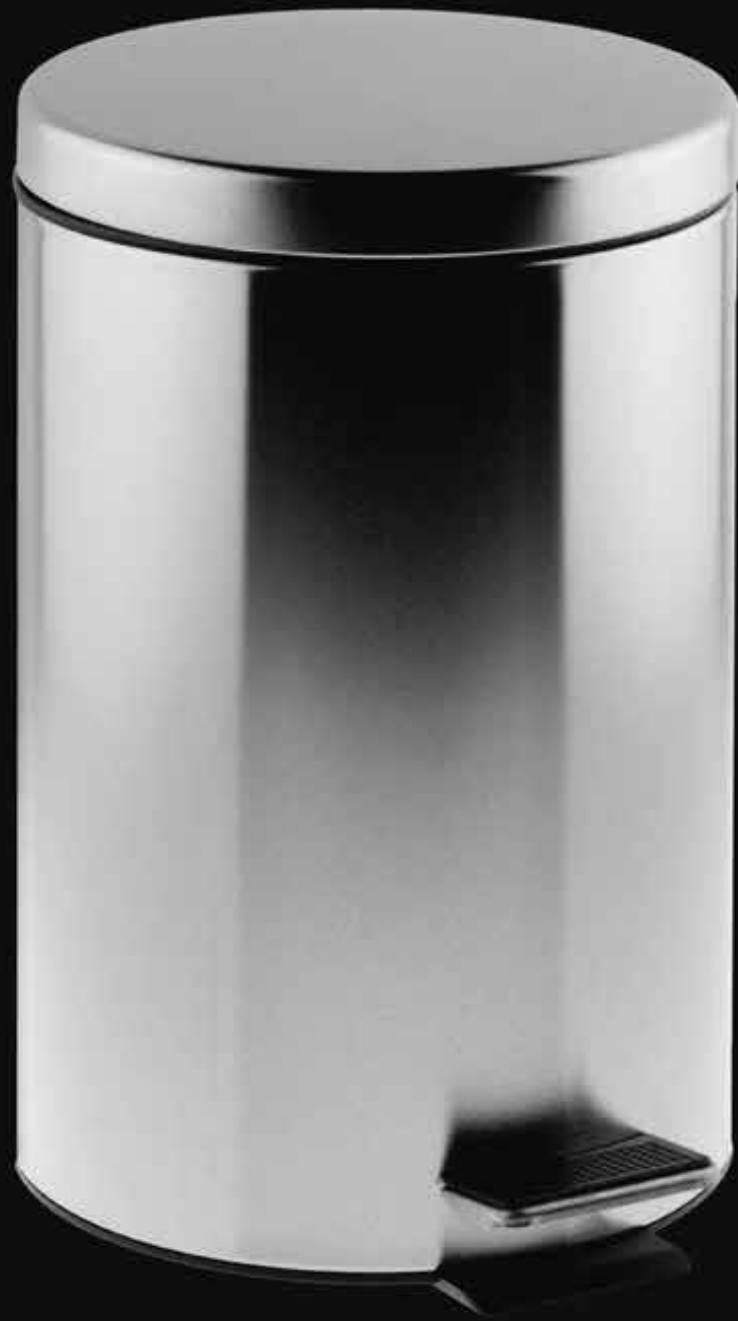

basket

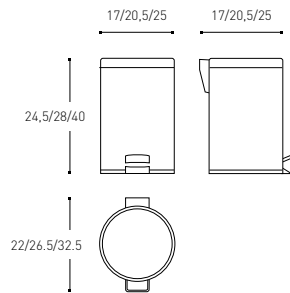

INCH 6.7/8.1/9.8x6.7/8.1/9.8x9.6/11/15.7

○ PAPELERA
WASTEBIN
POUBELLE
GETTACARTA
BALDE
ABFALLBEHÄLTER
PAPIERMAND

290 07 02 3 L. **\$ 590.00**
290 07 03 5 L. **\$ 720.00**
290 07 04 12 L. **\$ 1,070.00**

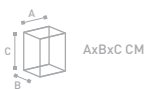





La elegancia se **inspira**
en la **calidez** de las
formas **naturales** y los
materiales. Líneas elegantes y
sofisticadas.

*Elegance inspired in the
warmth of natural
shapes and materials. Elegant and
sophisticated lines.*

orga nics

DESIGN BY RICARD FERRER

organics

Codificación / Code /
Codification / Codice / Codificação /
Kodifizierung / Codificatie

258 AA 21

COLECCIÓN / COLLECTION / COLLECTION /
COLLEZIONE / COLEÇÃO / KOLLEKTION / COLLECTIE

ACABADOS / FINISHES / FINITIONS / FINITURE / ACABAMENTOS /
OBERFLÄCHEN / AFWERKINGEN

MODELO / TYPE / MODÈLE / MODEL / MODELO / MODELL / MODEL



Características

Materiales de alta calidad resistentes a la corrosión. Mecanismo de pedal. Cubo interior de plástico extraíble.

Features

Rustproof high quality materials. Pedal mechanism. Removable plastic basket inside.

Caractéristiques :

Matériaux de haute qualité et résistants à la corrosion. Mécanisme à pédale. Récipient intérieur en plastique amovible.

Caratteristiche:

Materiali di alta qualità, resistenti alla corrosione. Meccanismo a pedale. Contenitore interno in plastica estraibile.

Características:

Materiais de alta qualidade resistentes à corrosão. Mecanismo de pedal. Cubo interior de plástico extraível.

Eigenschaften:

Korrosionsbeständige, hochwertige Materialien. Treteimer. Abnehmbarer kunststoffeinsatz.

Kenmerken:

Hoogwaardige materialen en corrosiebestendig. Pedaalmechanisme. Recipient in uitneembare kunststof.

Acabados Finishes Finitions Finiture Acabamentos Oberflächen Afwerkingen



Cromo
Chrome
Chrome
Cromo
Cromo
Chrom
Verchromd



06
Cromo-Negro
Chrome-Black
Chrome-Noir
Cromo-Nero
Cromo-Preto
Chrom-Schwarz
Verchromd-Zwart



05
Cromo-Blanco
Chrome-White
Chrome-Blanc
Cromo-Bianco
Cromo-Branco
Chrom-Weiss
Verchromd-Wit



79
Cromo-Visón
Chrome-Mink
Chrome-Vison
Cromo-Visone
Cromo-Vison
Chrom-Nerz
Verchromd-Muisgrijs



66
Cromo-Blanco roto
Chrome-Off white
Chrome-Blanc cassé
Cromo-Bianco rotto
Cromo-Branco sujo
Chrom-Beigeweis
Verchromd-Off white



organics

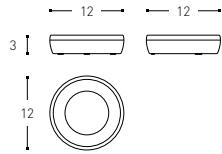

INCH 4.7x4.7x1.2

- ▲ JABONERA
- ▲ SOAP DISH
- ▲ PORTE-SAVON
- ▲ PORTASAPONE
- ▲ SABONETEIRA
- ▲ SEIFENSCHALE
- ▲ ZEEPPAKJE
- 258 AA 32**
- \$ 810.00**

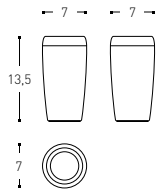

INCH 2.7x2.7x5.3

- ▲ VASO
- ▲ GLASS
- ▲ VERRE
- ▲ BICCHIERE
- ▲ COPO
- ▲ BECHER
- ▲ BEKER
- 258 AA 51**
- \$ 970.00**

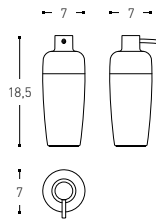

INCH 2.7x2.7x7.3

- ▲ DOSIFICADOR
- ▲ SOAP DISPENSER
- ▲ PORTE-SAVON LIQUIDE
- ▲ DISPENSER
- ▲ DOSEADOR SABONETE
- ▲ SEIFENSPENDER
- ▲ DOSEERDER
- 258 AA 04**
- \$ 1,300.00**

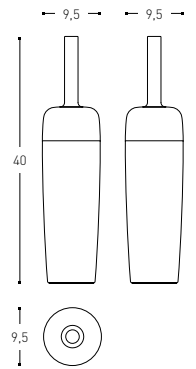

INCH 3.7x3.7x15.7

- ▲ ESCOBILLERO
- ▲ TOILET BRUSH
- ▲ PORTE-BALAYETTE
- ▲ PORTASCPINO
- ▲ PORTA-PIACABA
- ▲ TOILETTENBÜRSTENHALTER
- ▲ WC-BORSTELHOUDER
- 258 AA 00**
- \$ 2,580.00**

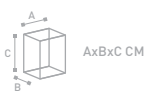

organics

recambios spare parts pièces détachées ricambi peças de reposição ersatzteile reserveonderdelen

**BOMBA DOSIFICADOR / DISPENSER PUMP / POMPE PORTE-SAVON LIQUIDE /
POMPETTA DISPENSER / BOMBA DISPENSADOR / DOSIERPUMPE SEIFENSPENDER /
DOSEERPOMPJE**

341 06 22 \$ 140.00

RECAMBIO DE / SPARE PART OF / PIÈCE DÉTACHÉE DE / RICAMBIO DI /
PEÇA DE REPOSIÇÃO DE / ERSATZTEIL FÜR / ONDERDEEL VAN
2580504, 2580604, 2586604, 2587904

**PULSADOR + BOMBA DOSIFICADOR / DISPENSER PUSH BUTTON + PUMP /
POUSSOIR + POMPE PORTE-SAVON LIQUIDE / PULSANTE + POMPETTA DISPENSER /
BOTÃO + BOMBA DOSEADOR / PUMPENKOPF FÜR SEIFENSPENDER / DRUKKNOP +
POMP VERDELER VLOEIBARE ZEEP**

341 06 18 \$ 300.00

RECAMBIO DE / SPARE PART OF / PIÈCE DÉTACHÉE DE / RICAMBIO DI /
PEÇA DE REPOSIÇÃO DE / ERSATZTEIL FÜR / ONDERDEEL VAN
2580504, 2580604, 2586604, 2587904

**PALO ESCOBILLERO CON CEPILLO / TOILET BRUSH STICK WITH BRUSH / MANCHE
BALAYETTE AVEC BROSSSE / MANICO SCOPINO CON SPAZZOLINO / ESCOVA COM
CABO PORTA-PIAÇABA / TOILETTENBÜRSTE MIT GRIFF / HANDVAT MET BORSTEL**

341 03 11 Blanco / White / Blanc / Bianco / Branco / Weiss / Wit \$ 970.00

RECAMBIO DE / SPARE PART OF / PIÈCE DÉTACHÉE DE / RICAMBIO DI /
PEÇA DE REPOSIÇÃO DE / ERSATZTEIL FÜR / ONDERDEEL VAN
2580500

341 03 12 Negro / Black / Noir / Nero / Preto / Schwarz / Zwart \$ 970.00

RECAMBIO DE / SPARE PART OF / PIÈCE DÉTACHÉE DE / RICAMBIO DI /
PEÇA DE REPOSIÇÃO DE / ERSATZTEIL FÜR / ONDERDEEL VAN
2580600

341 04 23 Blanco roto / Off white / Blanc cassé / Bianco rotto /
Branco sujo / Beigeweiss / Off white \$ 990.00

RECAMBIO DE / SPARE PART OF / PIÈCE DÉTACHÉE DE / RICAMBIO DI /
PEÇA DE REPOSIÇÃO DE / ERSATZTEIL FÜR / ONDERDEEL VAN
2586600

341 04 24 Visón / Mink / Vison / Visone / Vison / Nerz / Nerts \$ 990.00

RECAMBIO DE / SPARE PART OF / PIÈCE DÉTACHÉE DE / RICAMBIO DI /
PEÇA DE REPOSIÇÃO DE / ERSATZTEIL FÜR / ONDERDEEL VAN
2587900

**CEPILLO ESCOBILLERO / TOILET BRUSH BRUSH / BROSSSE PORTE-BALAYETTE /
SPAZZOLINO PORTASCOPILO / ESCOVA PARA PIAÇABA / TOILETTENBÜRSTENKOPF /
BORSTEL WC-BORSTELHOUDER**

341 03 13 Negro / Black / Noir / Nero / Preto / Schwarz / Zwart \$ 280.00

350 11 00 Blanco / White / Blanc / Bianco / Branco / Weiss / Wit \$ 280.00

RECAMBIO DE / SPARE PART OF / PIÈCE DÉTACHÉE DE / RICAMBIO DI /
PEÇA DE REPOSIÇÃO DE / ERSATZTEIL FÜR / ONDERDEEL VAN
2580500, 2580600, 2586600, 2587900





Formas **vegetales** que
crecen y **evolucionan**,
de ahí su nombre "**saku**",
florecer en **japonés**.

*Vegetable forms that
grow and **evolve**; thus its
name "**saku**", to flourish
in **japanese**.*

saku
DESIGN BY RICARD FERRER

Codificación / Code /
Codification / Codice / Codificação /
Kodifizierung / Codificatie

252 AA 21

COLECCIÓN / COLLECTION / COLLECTION /
COLLEZIONE / COLEÇÃO / KOLLEKTION / COLLECTIE

ACABADOS / FINISHES / FINITIONS / FINITURE / ACABAMENTOS /
OBERFLÄCHEN / AFWERKINGEN

MODELO / TYPE / MODÈLE / MODEL / MODELO / MODELL / MODEL

Acabados
Finishes
Finitions
Finiture
Acabamentos
Oberflächen
Afwerkingen

Características

Complementos realizados en PMMA
(poli metil metacrilato) recubiertos con
pintura transparente en acabado gomoso.

Features

Complements in PMMA (Polymethyl
methacrylate), coated in transparent paint
with a gummy finish.

Caractéristiques :

Compléments réalisés en PMMA
(polyméthacrylate de méthyle) recouverts
d'une peinture transparente gommeuse.

Caratteristiche:

Complementi realizzati in PMMA
(polimetilmetacrilato) ricoperti con vernice
trasparente in finitura gommata.

Características:

Acessórios fabricados em PMMA
(polimetilmetacrilato) revestidos com pintura
transparente em acabamento de borracha.

Eigenschaften:

Zubehör aus PMMA (Polymethylmethacrylat),
mit transparentem Gummilack beschichtet.

Kenmerken:

Accessoires in PMMA
(polymethylmethacrylaat), met een
transparente coating met rubberachtige
afwerking.



25
Blanco soft
Soft white
Blanc soft
Bianco soft
Branco soft
Weiß soft
Soft wit

05
Blanco brillo
Glossy white
Blanc brillant
Bianco lucido
Branco brilho
Weiß glänzend
Glanzend wit



26
Negro soft
Soft black
Noir soft
Nero soft
Preto soft
Schwarz soft
Soft zwart

06
Negro brillo
Glossy black
Noir brillant
Nero lucido
Preto brilho
Schwarz glänzend
Glanzend zwart



28
Gris soft
Soft gray
Gris soft
Grigio soft
Cinzeno soft
Grau soft
Soft grijs



27
Piedra soft
Soft stone
Pierre soft
Petra soft
Pedra soft
Stein soft
Soft steen



23
Gris azulado soft
Soft bluish gray
Gris bleuté soft
Grigio bluastró soft
Cinza azulado soft
Blaugrau soft
Soft blauwgrijs



saku

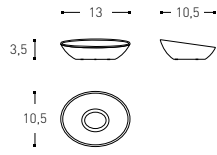

INCH 5.1x4.1x1.4

▲ JABONERA
SOAP DISH
PORTE-SAVON
PORTASAPONE
SABONETEIRA
SEIFENSCHALE
ZEEPBAKJE

252 AA 32 BRILLO / GLOSSY

\$ 340.00

NEW 252 AA 32 SOFT / SOFT
\$ 390.00

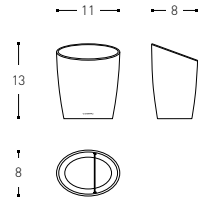

INCH 4.3x3.1x5.1

▲ VASO
GLASS
VERRE
BICCHIERE
COPO
BECHER
BEKER

NEW 252 AA 52 BRILLO / GLOSSY

\$ 390.00

NEW 252 AA 52 SOFT / SOFT
\$ 440.00

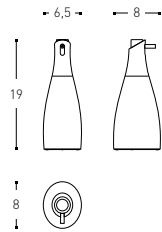

INCH 2.5x3.1x7.5

▲ DOSIFICADOR
SOAP DISPENSER
PORTE-SAVON LIQUIDE
DISPENSER
DOSEADOR SABONETE
SEIFENSPENDER
DOSEERDER

252 AA 04 BRILLO / GLOSSY

\$ 620.00

NEW 252 AA 04 SOFT / SOFT
\$ 710.00

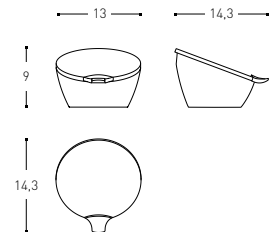

INCH 5.1x5.6x3.5

▲ ◆ FRASCO
POT
FLACON
SCATOLA
FRASCO
DOSE
POT

NEW 252 AA 49 BRILLO / GLOSSY

\$ 570.00

NEW 252 AA 49 SOFT / SOFT
\$ 710.00



INCH 4.1x3.5x15.1

▲ ESCOBILLERO
TOILET BRUSH
PORTE-BALAYETTE
PORTASCOPINO
PORTA-PIAÇABA
TOILETTENBÜRSTENHALTER
WC-BORSTELHOUDER

252 AA 00 BRILLO / GLOSSY

\$ 1,080.00

NEW 252 AA 00 SOFT / SOFT
\$ 1,170.00



saku

recambios spare parts pièces détachées ricambi peças de reposição ersatzteile reserveonderdelen

**BOMBA DOSIFICADOR / DISPENSER PUMP / POMPE PORTE-SAVON LIQUIDE /
POMPETTA DISPENSER / BOMBA DISPENSADOR / DOSIERPUMPE SEIFENSPENDER /
DOSEERPOMPJE**

341 06 82 \$ 140.00

RECAMBIO DE / SPARE PART OF / PIÈCE DÉTACHÉE DE / RICAMBIO DI /
PEÇA DE REPOSIÇÃO DE / ERSATZTEIL FÜR / ONDERDEEL VAN
2520504, 2520604, 2521404, 2522204, 2526604, 2526904

**CEPILLO ESCOBILLERO / TOILET BRUSH BRUSH / BROSE PORTE-BALAYETTE /
SPAZZOLINO PORTASCOPINO / ESCOVA PARA PIAÇABA / TOILETTENBÜRSTENKOPF /
BORSTEL WC-BORSTELHOUDER**

341 02 67 Negro / Black / Noir / Nero / Preto / Schwarz / Zwart \$ 260.00

RECAMBIO DE / SPARE PART OF / PIÈCE DÉTACHÉE DE / RICAMBIO DI /
PEÇA DE REPOSIÇÃO DE / ERSATZTEIL FÜR / ONDERDEEL VAN
2520500, 2520600, 2521400, 2522200, 2526600, 2526900



**dis
plays**

displays

3260822 ES

Codificación / Code /
Codification / Codice / Codificação /
Kodifizierung / Codificatie

COLECCIÓN / COLLECTION / COLLECTION /
COLLEZIONE / COLEÇÃO / KOLLEKTION / COLLECTIE

IDIOMA / LANGUAGE / LANGUE / LINGUA / IDIOMA /
SPRACHE / TAAL

EN ENGLISH
ES ESPAÑOL
RU РУССКИЙ

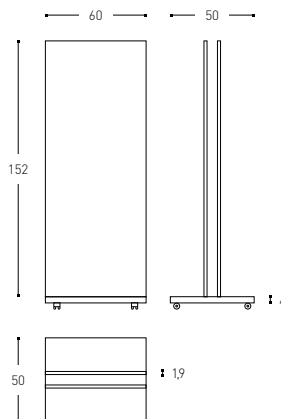

TOTEM DISPLAY
EXPOSITOR TOTEM
PRESENTOIR TOTEM
ESPOSITORE TOTEM
EXPOSITOR TOTEM
AUSSTELLER TOTEM
RECLAME ZUIL

326 70 03

INCH 23.6x19.7x59.8 / 1.6 / 0.7



architect

3260803AA 60x152 CM

CODIGO	DESCRIPCIÓN	PRECIO
2050121	COLGADOR CROMO	\$ 480.00
2050158	PORTAPAPEL SIN TAPA CROMO	\$ 1,100.00
2050164	TOALLERO (41,5CM) CROMO	\$ 1,420.00
2050120	PORTAGUANTES CROMO	\$ 280.00
2050159	PORTAPAPEL CON TAPA CROMO	\$ 1,370.00
2050171	TOALLERO ARO (22,5x12CM) CROMO	\$ 1,300.00
2050146	ESTANTE INOX (43CM) CROMO	\$ 1,900.00
2050122	COLGADOR DOBLE CROMO	\$ 1,280.00
2050103	DOSIFICADOR CROMO	\$ 1,460.00
2050153	PORTACEPILLOS CROMO	\$ 1,350.00
2050157	PORTAPAPEL DOBLE SIN TAPA CROMO	\$ 1,240.00
2050100	ESCOBILLERO CROMO	\$ 1,740.00



bath life

3260819AA 60x152 CM

CODIGO	DESCRIPCIÓN	PRECIO
2290169	TOALLERO (45CM) CROMO	\$ 2,010.00
2290105	DOSIFICADOR CROMO	\$ 2,560.00
2290152	PORTACEPILLOS CROMO	\$ 1,830.00
2290121	COLGADOR CROMO	\$ 770.00
2290140	BARRA ESTANTE (30CM) CROMO	\$ 2,170.00
2290545	ESTANTE BLANCO (30CM)	\$ 1,650.00
2290158	PORTAPAPEL CROMO	\$ 2,010.00
2290171	TOALLERO ARO (23x12CM) CROMO	\$ 1,620.00
2290162	PORTAPAPEL SIN TAPA	\$ 2,010.00
2290156	PORTAPAPEL CON TAPA CROMO	\$ 2,830.00
2290100	ESCOBILLERO SUELO/PARED BLANCO-CROMO	\$ 2,490.00

displays



project

3260822AA 60x152 CM

CODIGO	DESCRIPCIÓN	PRECIO
2510121	COLGADOR CROMO	\$ 730.00
2510100	ESCOBILLERO SUELO/PARED CROMO	\$ 2,720.00
2510158	PORTAPEPEL SIN TAPA CROMO	\$ 1,420.00
2510159	PORTAPEPEL CON TAPA CROMO	\$ 1,870.00
2510196	PORTAPEPEL SIN TAPA VERTICAL CROMO	\$ 1,560.00
2510164	TOALLERO (40CM) CROMO	\$ 1,900.00
2510105	DOSIFICADOR CROMO	\$ 2,010.00
2510171	TOALLERO ARO (20X15CM) CROMO	\$ 1,820.00
2510154	PORTACEPILLOS CROMO	\$ 1,820.00
2510144	ESTANTE VIDRIO (40CM) CROMO	\$ 1,850.00
2510157	PORTAPEPEL DOBLE SIN TAPA CROMO	\$ 1,970.00



minimalism

3260801AA 60x152 CM

CODIGO	DESCRIPCIÓN	PRECIO
2400148	CONTAINER (41CM) CROMO	\$ 1,870.00
2400164	TOALLERO (41,5CM) CROMO	\$ 1,600.00
2400175	TOALLERO GIRATORIO DOBLE (44CM) CROMO	\$ 2,580.00
2400158	PORTAPEPEL SIN TAPA CROMO	\$ 880.00
2400159	PORTAPEPEL CON TAPA CROMO	\$ 1,350.00
2400121	COLGADOR CROMO	\$ 560.00
2400171	TOALLERO ARO (16CM) CROMO	\$ 1,190.00
2510105	DOSIFICADOR CROMO	\$ 2,010.00
2510100	ESCOBILLERO PARED	\$ 2,720.00
2510154	PORTACEPILLOS CROMO	\$ 1,820.00

displays



inox

3260808AA 60x152 CM



black & white

3260827AA 60x152 CM



extreme

3260823AA 60x152 CM



organics

3260826AA 60x152 CM



logic

3260809AA 60x152 CM



working

3260814AA

salesconditions

EXPORT GENERAL SALES CONDITIONS

- 1**
The sales of INDUSTRIAS COSMIC S.A.U. are ruled by the herewith detailed general sales condition and the delivery of any order implies the buyer's acceptance of these general conditions.
- 2**
The products can be modified, replaced or cancelled at any time and all information of any kind included in our catalogues, price lists or advertising materials are indicative.
- 3**
Orders received from customers or through our salesmen are always subject to our previous approval and are considered confirmed unless otherwise specified.
- 4**
No order accepted by INDUSTRIAS COSMIC, S.A.U. can be amended or cancelled without our approval. The customer, as far as he is concerned, cannot return any goods to us without our previous acceptance or consent. In case the customer wants to cancel or amend an order that has been already shipped, due to INDUSTRIAS COSMIC, S.A.U. external causes, the customer will be charged with a € 50 invoice (VAT non included) as return management expenses.
- 5**
Goods will be invoiced in accordance with our current price list at the moment of shipment. The prices are F.O.B. Barcelona for orders above € 1,500; for orders below € 1,500 goods will be shipped under Ex-Works conditions.
- 6**
Unless otherwise agreed, the payment terms are:
-Irrevocable Letter of Credit at sight
-Advanced Bank Transfer
-Cash Against Documents
- 7**
INDUSTRIAS COSMIC, S.A.U. offers two years guarantee, in exception of the indicated in the price list, against raw material and manufacturing defects. The guarantee is valid from the time of purchase by the final customer. To confirm the date of purchase, the invoice of the consumer should be provided. The guarantee consists of the replacement of the defective piece that impedes the regular use of the item, except in case of improper use, incorrect assembly or installation, natural wear and tear, improper maintenance or, chemical, electrochemical or electrical influences. We are not responsible for all the damage brought about by misuse or bad installation of the products and won't accept any indemnities for the replacement of defective pieces or any demands for damage.
- 8**
INDUSTRIAS COSMIC, S.A.U. always try to minimize the customer service time and to meet the lead time requirements on our customers' orders as much as possible. In case we cannot satisfy them, customers will be duly advised.
- 9**
Ordered COSMIC products will be delivered under reservation of title in favour of INDUSTRIAS COSMIC, S.A.U. until all payment obligations by the purchaser have been met in full.
- 10**
In case of outstanding payments, the return and bank expenses are on the purchaser's. INDUSTRIAS COSMIC S.A.U. has the right to block all orders accepted as long as the outstanding payments are not sorted out.
- 11**
In case of claims regarding the interpretation or execution of the herewith sales conditions, will be competent the courts of our head office's jurisdiction.

CONDICIONES GENERALES DE VENTA EXPORTACIÓN

- 1**
Las ventas de INDUSTRIAS COSMIC, S.A.U. se realizan según las condiciones generales aquí expuestas y la entrega de cualquier pedido supone la aceptación, por parte del comprador, de dichas condiciones generales de venta.
- 2**
Los productos se pueden modificar, reemplazar o suprimir en todo momento y la información de cualquier naturaleza contenida en nuestros catálogos, tarifas o material publicitario es indicativa.
- 3**
Los pedidos recibidos directamente de los clientes o realizados por nuestros representantes en nombre de ellos siempre estarán sujetos a nuestra aceptación. INDUSTRIAS COSMIC, S.A.U. da por confirmados todos los pedidos recibidos y, si no hay notificación específica se entenderán como aceptados.
- 4**
Ningún pedido aceptado por nosotros se podrá retractar ni anular sin nuestra aceptación. El cliente, por su parte, no podrá efectuar ninguna devolución de mercancía sin nuestro consentimiento previo. En el caso de anulación o modificación por parte del cliente y por causas ajenas a INDUSTRIAS COSMIC, S.A.U., de un pedido que ya haya sido expedido, se le facturará al cliente un importe de 50€ netos (IVA no incluido) en concepto de gastos de gestión y transporte.
- 5**
La mercancía será facturada de acuerdo con nuestra tarifa vigente en el momento del envío. Los precios serán F.O.B. Barcelona para pedidos superiores a 1.500€. Los pedidos inferiores a 1.500€ serán enviados ExWorks.
- 6**
De no existir otro acuerdo, las condiciones de pago serán:
-Letra de crédito irrevocable a la vista
-Transferencia por avanzado
-Contado contra documento
- 7**
INDUSTRIAS COSMIC, S.A.U. ofrece una garantía de 2 años, excepto en los casos indicados en la tarifa, contra todos los defectos de materia prima y fabricación válida a partir del momento de adquisición por parte del cliente final. A fin de determinar la fecha de adquisición será imprescindible la presentación de la factura de compra. Esta garantía consistirá en la sustitución de la pieza que determine su irregular funcionamiento, salvo por razones de uso inadecuado, montaje o instalación incorrectos, mantenimiento indebido, desgaste del uso diario o defectos provocados por reacciones químicas, electroquímicas o eléctricas. La garantía excluye de responsabilidad a INDUSTRIAS COSMIC, S.A.U. de todas las consecuencias derivadas del funcionamiento o instalación de nuestros productos y esta no reconoce ninguna indemnización por la sustitución de artículos defectuosos ni demanda por daños y perjuicios.
- 8**
INDUSTRIAS COSMIC, S.A.U. intenta siempre reducir al máximo los tiempos de servicio al cliente, ajustándose en lo posible a los requisitos de plazo solicitados expresamente en el pedido y, en caso de no poder satisfacerlos, se enviará una notificación.
- 9**
Los productos marca COSMIC, objeto de pedido, se entregarán bajo reserva de dominio a favor de INDUSTRIAS COSMIC, S.A.U. hasta el total cumplimiento de las obligaciones de pago por parte del comprador.
- 10**
En caso de impagos, se incurre en un cargo por devolución, más los gastos de financiación actuales en el mercado. INDUSTRIAS COSMIC, S.A.U. se reserva el derecho de retener los pedidos en curso hasta solucionar los efectos pendientes.
- 11**
Las disputas referentes a la interpretación o a la ejecución de estas condiciones generales de venta pasarán a ser competencia de los tribunales de nuestra jurisdicción.

technical specifications

MATERIALS



FLOAT GLASS (flat shelves and washbasin tops)

This material is solely mechanized, cut, and polished. Though we utilized the most durable thickness, special care must be taken to ensure this naturally fragile material will last. To maintain the appearance of this glass, avoid contact with hard or sharp materials that could scratch the surface. Many of these products have one side engraved with acid that should be facing down to facilitate cleaning and make any possible scratching less visible. We recommend using soapy water to clean both the top and bottom surfaces.



PRESSED GLASS (glasses and soap dishes in most collections)

This material is manufactured similarly to FLOAT glass, with the added steps of melting and shaping. To maintain the appearance of this glass, avoid contact with hard or sharp materials that could scratch the surface. To clean, we recommend the use of soapy water.



TEMPERED GLASS

This material is manufactured similarly to FLOAT glass, but also undergoes a thermal processing to increase its resistance. Though stronger than FLOAT glass, the same care should be applied. To maintain the appearance of this glass, avoid contact with hard or sharp materials that could scratch the surface. To clean, we recommend the use of soapy water.



MIRRORS

As we use only top quality raw materials and follow appropriate manufacturing processes, our mirrors have maximum protection against corrosion stains. However, it is highly important to avoid rubbing or scratching the underside of any mirror during installation, as this can lead to corrosion staining over time. We recommend the use of mild cleaning agents that contain no acetones or similar substances.



SYNTHETIC RESIN

This material is made of alumina hydroxide (marble dust) and polyester and acrylic resins. We recommend using a wet washcloth and soapy water to clean this surface and maintain its matte appearance. This material is resistant to many chemical products including alcohol, acetone, bleach, etc., but in the case of prolonged exposure to these substances, the surface should be rinsed thoroughly. Dyes must be cleaned immediately to prevent staining. Please note: this material is light sensitive and its color can develop a yellow tint over time. If you notice a change with this material, the use of Scotch Brite will restore its original finish and color.



PHENOLIC RESIN

This material is a high pressure laminate (HPL) with a decorative surface. Typically the superficial layer consists of thermo-hardened resin-treated plywood. The special texture and durability of this material makes it very resistant to impact and scratching, and it is completely waterproof. Specially designed for use in places where hygiene is of the utmost importance, this material can be cleaned frequently with active detergents, chemical agents, or organic solvents.



VENEERED WOOD

Veneered wood: Plywood. The inner plywood of surfaces is waterproof DM + sheets of: clear oak, Wengé-coloured oak, American walnut. To avoid its yellowing, they are varnished with high quality materials. This kind of surface must be treated and cleaned like many other pieces of furniture, using specific products like wood care products.



LACQUERED WOOD

This material is made from 16mm-thick double-faced waterproof MDF plywood. Its high quality varnish provides a bright or matte finish and prevents yellowing. Due to its delicate lacquered surface, we recommend the use of mild cleaning products, avoiding solvents or any abrasive substances.



PVC / PVC

Polyvinyl chloride (PVC) is a polyvinyl chloride polymer used to manufacture numerous products and is also applied in making boards, panels, windows, shutters, etc. Its durability, colour stability, watertightness and moisture proof properties make PVC an ideal material for bathroom and kitchen furniture. The material can be cleaned quickly and easily with just soap and water, although its resilience means most cleaning products can also be used.



PLASTIC

We use various technical plastics with different features to meet the manufacturing and aesthetic needs of each product. These include ABS (with or without chrome), PP, PA, PE, PC, PS, PMMA, etc. We recommend maintaining decorative items the same way you would chrome brass pieces. Avoid the use of solvents.



PLEXIGLAS (polymethacrylate)

This material is a plastic of great rigidity used as a substitute for glass and is often more transparent. As with other plastics, avoid the use of solvents when cleaning, as well as any other substances that could damage the surface.



STAINLESS STEEL (bright and matte)

This material is made of certain alloys such as AISI 303, 304, 316, or 430, depending on the requirements for each item. To maintain its quality, regular maintenance must be applied. To clean this material, we recommend the use of soapy water, followed by a thorough rinsing. Finish by wiping the surface dry with a cloth or soft leather. Avoid using strong or abrasive substances, especially those containing acids or bleach. If cleaned inappropriately, this material can develop lime scale deposits that cause deterioration.



BRASS OR SIMILAR ALLOYS (bright chrome or matte chrome)

We apply a nickel or chrome coating over a brass base to make this material. To maintain its quality, regular maintenance must be applied. To clean this material, we recommend the use of soapy water, followed by a thorough rinsing. Finish by wiping the surface dry with a cloth or soft leather. Avoid using strong or abrasive substances, especially those containing acids or bleach. If cleaned inappropriately, this material can develop lime scale deposits that cause deterioration.



GLASS-LINED STEEL (VIT-TECH)

Cutting-edge, 100% recyclable, non-porous and hygienic material made from pre-enamelled steel fired at over 800°. The vitreous enamel withstands corrosion, high temperatures and chemical agents. This durability means it can be used for a wide range of functional applications in bathtubs, shower trays and washbasins, as well as for ovens and coatings. It is an easy to clean material that does not require special cleaning products.



TECKSTONE

Advanced formula composed by natural minerals (calcium carbonate and quartz) mixed with resin. The surface is covered by Gelcoat Premium Maxguard™ film, with plastic fibre and polymer, which provides the needed durability and resistance for an intensive daily use. It is a solid surface with excellent physic-mechanical properties that supplies important design possibilities. Its capacity of moulding allows reproducing forms with a great precision and with less curvature radius. Teckstone is very hard, resistant and compact; being a non porous material and without angles, it is very easy to maintain, the stains can be eliminated without effort and it is easy to clean. For the maintenance, wash with a soft cloth and dry with a chamois. We recommend not to use abrasive cloth or scourers, acid detergents, bleach ... and/or cleaning products with unknown components.

technical specifications

MATERIALES



VIDRIO FLOAT (Estantes y encimeras)

Realizado con vidrio tipo FLOAT estándar sin ningún otro tratamiento posterior más que la mecanización, corte y pulido necesarios. Se trata, pues, de un material que por su propia naturaleza es frágil y a pesar de que en cada caso se ha utilizado el espesor más adecuado, debe tenerse un especial cuidado en su uso. Para conseguir que el buen aspecto inicial del producto se mantenga a lo largo de los años, se recomienda no depositar artículos fabricados con materiales duros que pudieran rayar la superficie. Muchos de nuestros artículos tienen una cara gravada al ácido (mate o traslúcida). Se recomienda que esta cara mate, se instale en la cara inferior, para facilitar la limpieza, y evitar que posibles ralladuras sean más visibles. Para la limpieza de ambas superficies es suficiente con agua jabonosa.



VIDRIO PENSADO (Vasos y jaboneras de la mayoría de nuestras series)

Material muy similar al vidrio FLOAT utilizado en estantes y encimeras, este vidrio fundido es conformado en un molde. El uso y cuidados deben ser los mismos que para estantes y encimeras.



VIDRIO TEMPLADO

Vidrio FLOAT sometido a tratamiento térmico para aumentar su resistencia.



ESPEJOS

Cosmic utiliza materia prima de primera calidad que, unido a un correcto proceso de fabricación de los espejos, aseguran la mayor protección contra las manchas por corrosión. Es importante evitar, en especial durante el proceso de instalación, roces o ralladuras en la cara oculta del espejo, que con el tiempo podrían dar origen a manchas de corrosión. Para su limpieza se recomienda utilizar productos suaves y en ningún caso acetonas o similares.



RESINA SINTÉTICA

Mezcla de Hidróxido de alumina (polvo de mármol) con resinas sintéticas de poliéster y acrílicas. Para su mantenimiento sólo es necesario el uso de agua y un poco de jabón neutro (también puede utilizarse desengrasante, tipo lavavajillas), enjuagar y secar. Si se desea conservar el aspecto mate se puede utilizar, para su limpieza, un estropajo de material plástico con agua y jabón (no en seco), si con el tiempo coge un aspecto brillante bastará con utilizar un estropajo de fibra plástica para recuperar su aspecto inicial. Resiste la mayoría de productos químicos tales como: alcohol, acetona, lejía, etc, pero en el caso de contacto prolongado aclarar con abundante agua, si persiste la mancha se puede frotar con estropajo de fibra plástica o un producto abrasivo en polvo. En el caso de manchas de tintes, solo es necesario tener la precaución de limpiar las manchas rápidamente. El material es sensible a la luz ultravioleta. Puede amarillear levemente, en especial el primer año. Si se limpia con estropajo de fibra plástica se eliminará esta capa inicial, atacada por la luz, recuperando el color original. Aunque se trate de una superficie muy resistente, no deben utilizarse elementos duros o cortantes.



RESINA FENÓLICA

La Resina Fenólica o Stratificato es un laminado de alta presión (HPL) con superficie decorativa. En general, la capa superficial está constituida por una superficie dura, basada en resinas de melamina, mientras que el grueso está constituido por un contrachapado impregnado de resina termo endurecida que le confiere al material una excepcional resistencia al impacto. Su especial textura y su durabilidad proporcionan a nuestros muebles una excelente resistencia al rayado. Gracias a su superficie perfectamente impermeable es un material resistente al desgaste, al agua y al vapor. A fin de dar solución a las normas más exigentes en materia de higiene, puede limpiarse frecuentemente con detergentes activos ofreciendo alta resistencia a los agentes químicos y disolventes orgánicos. Especialmente indicado para su uso en áreas donde la higiene desempeña un papel fundamental.



MADERA CHAPADA

Aglomerado (para encimeras el Aglomerado interior es DM hidrófugo) + chapa de roble claro, roble Tintado Wengué o nogal americano. Barnizado con materiales de primera calidad que evitan el amarillamiento. Este tipo de superficies deben ser tratadas y limpiadas como cualquier otro mueble, con productos específicos para la madera.



MADERA LACADA

Aglomerado DM hidrófugo de 16mm melaminado dos caras y lacado en acabados brillo y mate con barnices de primera calidad resistentes y que evitan el amarillamiento. Las superficies lacadas son delicadas y deben ser tratadas y limpiadas cuidadosamente, utilizando productos específicos para estas superficies. No usar nunca disolventes o productos abrasivos.



PVC

El cloruro de polivinilo (PVC) es un polímero de cloruro de vinilo que se emplea para la fabricación de multitud de productos, encontrando aplicación en la realización de tableros, paneles, ventanas, persianas, etc. La larga durabilidad, estabilidad del color, estanqueidad al agua y resistencia a la humedad, son las características que hacen del PVC un material idóneo para muebles de baño y de cocina. La limpieza de este material es fácil y rápida y se realiza con agua y jabón, aunque por su resistencia permite el empleo la mayoría de productos de limpieza.



PLÁSTICO

Cosmic utiliza plásticos técnicos de distintas características en función de las necesidades de fabricación y estéticas de cada producto o pieza. Entre los plásticos utilizados están: ABS (cromado o no), PP, PA, PE, PC, PS, PMMA, etc. En el caso de piezas decorativas deben tenerse los mismos cuidados en la limpieza y mantenimiento que para una pieza de latón cromado. Evitar el uso de disolventes.



METACRILATO (Polimetacrilato)

Plástico de gran rigidez que se utiliza habitualmente como sustituto del vidrio, siendo incluso, más transparente que éste. Al igual que con el resto de plásticos, evitar el uso de disolventes para su limpieza, así como, materiales que pudieran dañar la superficie.



INOX (Acero inoxidable brillo y mate)

Para la fabricación de nuestros productos de acero inoxidable, se utilizan aleaciones como AISI 303, 304, ó 430 en función de las necesidades de cada pieza. Para asegurar una larga vida al producto es necesario realizar un mantenimiento periódico consistente en conservar la pieza limpia. Para la limpieza utilizar agua jabonosa, luego aclarar con abundante agua y finalmente secar con un paño o gamuza suave. Nunca utilizar productos fuertes, que contengan ácidos, lejía, o sean abrasivos. Los depósitos de cal, por falta de una limpieza regular, son el principal riesgo de deterioro.



LATÓN O ALEACIONES ANÁLOGAS (cromo brillante y cromo mate)

Sobre la base de latón se aplica un recubrimiento de Níquel y Cromo. Para asegurar una larga vida al producto es necesario realizar un mantenimiento periódico que consiste únicamente en mantener la pieza limpia. Para la limpieza utilizar agua jabonosa, luego aclarar con abundante agua y finalmente secar con un paño o gamuza suave. Nunca utilizar productos fuertes, que contengan ácidos, lejía, o sean abrasivos. Los depósitos de cal, por falta de una limpieza regular, son el principal riesgo de deterioro de este producto.



ACERO VITRIFICADO (VIT-TECH)

Material tecnológicamente avanzado y 100% reciclable que nace de la cocción de una superficie de acero esmaltada previamente. Es un material no poroso, higiénico y resistente a la corrosión, a las altas temperaturas y a agentes químicos debido a la naturaleza vítrea del esmalte. Esta característica le confiere una gran dureza permitiendo una amplia gama de aplicaciones en bañeras, platos de ducha y lavabos así como hornos y revestimientos. Es un material de fácil limpieza que no requiere la utilización de productos de limpieza específicos.



TECKSTONE

Formulación avanzada compuesta de minerales naturales (carbonato de calcio y cuarzo) mezclados con resina. La película Gelcoat Premium Maxguard™, con fibras de plástico y polímeros, recubre la superficie proporcionando la durabilidad y resistencia que necesita el uso diario intensivo. Se trata de una superficie sólida con excelentes propiedades físico-mecánicas que ofrece grandes posibilidades de diseño. Su capacidad de moldeo permite reproducir formas con gran precisión y con menores radios de curvatura. Teckstone es muy resistente, compacto y de gran dureza. Al ser un material no poroso y carente de juntas, su mantenimiento es muy sencillo, las manchas se eliminan sin esfuerzo y es de fácil limpieza. Para su mantenimiento, limpiar con un paño suave humedecido con agua y secar con una gamuza. No usar trapos o estropajos abrasivos, detergentes ácidos, lejías... y/o productos de los que desconozca su composición.

Rubinettería



RUBINETTERIA CARAIBICO SA DE CV

RCA 141006 UKO

Carretera Federal s/n Mz. 30 Lote 03,
esq. Av. Solidaridad.
Plaza Steren Local 10
Col. Playa del Carmen
Playa del Carmen, Q. Roo
C.P. 77710

984 188 6113

info@rubinetteria.com.mx

www.rubinetteria.com.mx